

## Series 358

# Granville-Phillips® Series 358 Micro-Ion® Vacuum Gauge Controller



## Instruction Manual

*Instruction manual part number 358013*

*Revision 09 - June 2008*



# Granville-Phillips® Series 358 Micro-Ion® Vacuum Gauge Controller

This Instruction Manual is for use with all Granville-Phillips Series 358 Micro-Ion Vacuum Gauge Controllers. A list of applicable catalog numbers is provided on the following page.



To order products online, visit [www.brooks.com](http://www.brooks.com)

For customer service, 24 hours per day, 7 days per week, every day of the year including holidays, toll-free within the USA, phone 1-800-367-4887

For customer service within the USA, 8 AM to 5 PM weekdays excluding holidays:

- Toll-free phone: 1-800-776-6543
- Phone: 1-303-652-4400
- FAX: 1-303-652-2844
- Email: [co-csr@brooks.com](mailto:co-csr@brooks.com)
- Web: [www.brooks.com](http://www.brooks.com)

# Granville-Phillips® Series 358 Micro-Ion® Vacuum Gauge Controller

## Catalog numbers for Series 358 Micro-Ion Controllers

Controller for a Micro-Ion gauge, with 3-line display, electron bombardment degas, and remote input/output interface - CE Marked <sup>(1)</sup>

<b>Half-rack mount:</b>	358501 - # # # - # #
<b>Left mount for 19-inch rack:</b>	358502 - # # # - # #
<b>Center mount for 19-inch rack:</b>	358503 - # # # - # #
<b>Black Case &amp; Half-rack mount:</b>	358504 - # # # - # #
<b>Black Case &amp; Left mount for 19-inch rack:</b>	358505 - # # # - # #

### Interface options (Slot X):

None  
RS-232  
RS-485/422

0  
A  
B

### Gauge options (Slot Y):

None  
Dual Convectron  
Capacitance Manometer/Convectron <sup>(1)</sup>

0  
1  
2

### Setpoint options (Slot Z):

None  
2 setpoint relays for Micro-Ion gauge  
6 setpoint relays, 2 per channel

0  
A  
B

### Display options (Measurement units):

Torr  
mbar  
Pascal

T  
M  
P

### Powercord options:

North America 115 V  
North America 240 V  
Universal Europe 220 V  
United Kingdom 240 V

1  
2  
3  
4

NOTE: <sup>(1)</sup> The Capacitance Manometer/Convectron Gauge option is not CE Marked.

# Table of Contents

<b>Chapter 1</b>	<b>Before You Begin</b> . . . . .	<b>9</b>
	1.1 Caution and Warning Statements . . . . .	9
	1.2 Reading and Following Instructions . . . . .	9
	1.3 Damage Requiring Service . . . . .	10
	1.4 Pressure Relief Devices . . . . .	11
	1.5 Certification . . . . .	11
	1.6 Warranty Information . . . . .	11
	1.7 Service Guidelines . . . . .	11
	1.8 FCC Verification . . . . .	12
<b>Chapter 2</b>	<b>System Components</b> . . . . .	<b>13</b>
	2.1 Options . . . . .	17
	2.2 RS-232 Specifications . . . . .	18
	2.3 RS-485 Specifications . . . . .	19
	2.4 Specifications . . . . .	20
	2.5 Dimensions . . . . .	23
	2.6 Mounting Options . . . . .	25
<b>Chapter 3</b>	<b>Initial Setup</b> . . . . .	<b>27</b>
	3.1 Controller Setup . . . . .	27
	3.2 Top Cover Removal . . . . .	27
	3.3 Pressure Units Setup . . . . .	28
	3.4 Changing Units of Measure for Electrometer Module . . . . .	28
	3.5 Overpressure Shutdown Adjustment . . . . .	30
	3.6 Changing Display Update Rate on Electrometer Module . . . . .	30
	3.7 Changing Units of Measure for Convectron Gauge . . . . .	30
	3.8 Display Update Rate Switch on Convectron Module . . . . .	31
	3.9 Changing Units of Measure for a Capacitance Manometer . . . . .	31
	3.10 Process Control Setup . . . . .	32
	3.11 Relay Polarity Setting . . . . .	35
	3.12 RS-232 Computer Interface Setup . . . . .	37
	3.13 RS-485 Computer Interface Setup . . . . .	42
	3.14 Replacing the Controller Cover . . . . .	47

<b>Chapter 4</b>	<b>Installation</b>	<b>49</b>
	4.1 Gauge Installation Tips	49
	4.2 FCC and EU Installation Requirements	49
	4.3 Cable Installation	50
	4.4 Environmental Conditions	50
	4.5 Controller Installation	50
	4.6 Mounting Configurations	51
	4.7 Line Voltage	53
	4.8 Fuse Replacement	53
	4.9 Vacuum Gauge Installation	53
	4.10 Mounting Options	54
	4.11 Grounding the System	55
	4.12 Connecting Analog Outputs	59
	4.13 Connecting a Capacitance Manometer	60
	4.14 Connecting Process Control Relays	63
	4.15 Connecting the RS-232 Computer Interface Handshake Lines	65
	4.16 Connecting RS-485 Computer Interface	66
<b>Chapter 5</b>	<b>Preparing for Operation</b>	<b>67</b>
	5.1 Preparing for Pressure Measurement	67
	5.2 Alternate ON/OFF Gauge Control	68
	5.3 Micro-Ion Gauge Remote Input/Output	68
	5.4 Micro-Ion Analog Output Signal	69
	5.5 Preparing for Convectron Gauge Operation	71
	5.6 Gases other than Nitrogen or Air	71
	5.7 Micro-Ion Gauge Auto ON/OFF	80
	5.8 Filament Auto ON	80
	5.9 Gauge Zero and Atmospheric Pressure Adjustment	81
	5.10 Convectron Gauge Analog Output Signal	82
	5.11 Preparing for Capacitance Manometer Operation	84
	5.12 Preparing for Process Control Operation	85
	5.13 Preparing to use RS-232 Computer Interface	87
	5.14 RS-232 Error Messages	90
	5.15 Preparing to Use RS-485 Computer Interface	90
	5.16 RS-485 Error Messages	93
<b>Chapter 6</b>	<b>Operation</b>	<b>95</b>
	6.1 Controller Operation	95
	6.2 Micro-Ion Gauge ON/OFF	97
	6.3 Degas ON/OFF	97
	6.4 Special Considerations for Use Below $10^{-3}$ Torr	98
	6.5 Gauge Electrometer Operation	98
	6.6 Filament Selection for Electrometer Module	100

---

<b>Chapter 7</b>	<b>Theory of Operation</b> . . . . .	<b>101</b>
	7.1 Micro-Ion Gauge Theory of Operation . . . . .	101
	7.2 Convectron Gauge Theory of Operation . . . . .	102
	7.3 Microcontrollers and Bus Structure . . . . .	103
	7.4 Capacitance Manometer Theory of Operation . . . . .	103
	7.5 Process Control Theory of Operation . . . . .	103
<b>Chapter 8</b>	<b>Service</b> . . . . .	<b>105</b>
	8.1 Service Guidelines . . . . .	105
	8.2 Customer service . . . . .	106
	8.3 Damage Requiring Service . . . . .	106
	8.4 Returning a Damaged Product . . . . .	106
	8.5 Troubleshooting . . . . .	107
	8.6 Overpressure Shutdown . . . . .	109
	8.7 Troubleshooting the Convectron Gauge Module . . . . .	110
	8.8 Capacitance Manometer Troubleshooting . . . . .	112
	8.9 Process Control Troubleshooting . . . . .	112
	8.10 RS-232 Troubleshooting . . . . .	113
	8.11 RS-485 Troubleshooting . . . . .	114
	8.12 Field Installation of a Module . . . . .	115





# Chapter 1 Before You Begin

## 1.1 Caution and Warning Statements

This manual contains caution and warning statements with which you *must* comply to prevent inaccurate measurement, property damage, or personal injury.



### CAUTION

**Caution statements alert you to hazards or unsafe practices that could result in minor personal injury or property damage.**

Each caution statement explains what you must do to prevent or avoid the potential result of the specified hazard or unsafe practice.



### WARNING

**Warning statements alert you to hazards or unsafe practices that could result in severe property damage or personal injury due to electrical shock, fire, or explosion.**

Each warning statement explains what you must do to prevent or avoid the potential result of the specified hazard or unsafe practice.

Caution and warning statements comply with American Institute of Standards Z535.1–2002 through Z535.5–2002, which set forth voluntary practices regarding the content and appearance of safety signs, symbols, and labels.

Each caution or warning statement explains:

- a. The specific hazard that you *must* prevent or unsafe practice that you *must* avoid,
- b. The potential result of your failure to prevent the specified hazard or avoid the unsafe practice, and
- c. What you *must* do to prevent the specified hazardous result.

## 1.2 Reading and Following Instructions

You must comply with all instructions while you are installing, operating, or maintaining the module. Failure to comply with the instructions violates standards of design, manufacture, and intended use of the module. Brooks Automation, Inc./ Granville-Phillips disclaim all liability for the customer's failure to comply with the instructions.

- *Read instructions* – Read all instructions before installing or operating the product.
- *Retain instructions* – Retain the instructions for future reference.

- *Follow instructions* – Follow all installation, operating and maintenance instructions.
- *Heed warnings and cautions* – Adhere to all warnings and caution statements on the product and in these instructions.
- *Parts and accessories* – Install only those replacement parts and accessories that are recommended by Granville-Phillips. Substitution of parts is hazardous.

**1.3 Damage Requiring Service**

Disconnect the product from the wall outlet and all power sources and refer servicing to qualified service personnel under the following conditions:

1. When any cable or plug is damaged.
2. If any liquid has been spilled onto, or objects have fallen into, the product.
3. If the product has been exposed to rain or water.
4. If the product does not operate normally even if you follow the operating instructions. Adjust only those controls that are covered by the operation instructions. Improper adjustment of other controls may result in damage and will often require extensive work by a qualified technician to restore the product to its normal operation.
5. If the product has been dropped or the enclosure has been damaged.
6. When the product exhibits a distinct change in performance. This indicates a need for service.



**WARNING**

**Substitution or modifying parts can result in product damage or personal injury due to electrical shock or fire.**

- Install only those replacement parts that are specified by Brooks Automation, Inc./ Granville-Phillips.
- Do not install substitute parts or perform any unauthorized modification to the controller.
- Do not use the controller if unauthorized modifications have been made.

## 1.4 Pressure Relief Devices



### WARNING

**Failure to install appropriate pressure relief devices for high-pressure applications can cause product damage or personal injury.**

For automatic backfilling and other applications in which malfunction or normal process conditions can cause high pressures to occur, install appropriate pressure relief devices.

Suppliers of pressure relief valves and pressure relief disks are listed in the *Thomas Register* under “Valves, Relief”, and “Discs, Rupture”.

Confirm that these safety devices are properly installed before installing the product. In addition, check that:

1. The proper gas cylinders are installed,
2. Gas cylinder valve positions are correct on manual systems, and
3. The automation is correct on automated gas delivery systems.

Vacuum gauges with compression fittings may be forcefully ejected if the vacuum system is pressurized.

## 1.5 Certification

Brooks Automation, Inc./ Granville-Phillips certifies that this product met its published specifications at the time of shipment from the factory. Brooks Automation, Inc./ Granville-Phillips further certifies that its calibration measurements are traceable to the National Institute of Standards and Technology to the extent allowed by the Institute's calibration facility. See also CE Declaration of Conformity inside envelope for CE tests performed.

## 1.6 Warranty Information

Brooks Automation, Inc./ Granville-Phillips provides an eighteen (18) month warranty from the date of shipment for new Granville-Phillips products. The Brooks Automation, Inc./ Granville-Phillips general terms and conditions of sale provide the complete and exclusive warranty for Brooks Automation, Inc./ Granville-Phillips products. This document is located on our web site at [www.brooks.com](http://www.brooks.com), or may be obtained by a contacting Brooks Automation, Inc./ Granville-Phillips customer service representative.

## 1.7 Service Guidelines

Some minor problems are readily corrected on site. If the product requires service, please contact our Customer Service Department for troubleshooting help over the phone.

For customer service:

- Phone **1-303-652-4400** or **1-800-776-6543** within the USA.
- Phone **1-800-367-4887** 24 hours per day, 7 days per week within the USA.

- Email [co-csr@brooks.com](mailto:co-csr@brooks.com)
- For Global Customer Support, go to [www.brooks.com](http://www.brooks.com), click on Contact Us, then click on Global Offices to locate the Brooks Automation office nearest you.

If a product must be returned for service, request a Return Authorization (RA) from Brooks Automation, Inc. / Granville-Phillips. Do not return products without first obtaining an RA. In some cases a hazardous materials document may be required. The Brooks Automation / Granville-Phillips Customer Service Representative will advise you if the hazardous materials document is required.

When returning equipment to Brooks Automation Inc. / Granville-Phillips, be sure to package the products to prevent shipping damage. Circuit boards and modules separated from the controller chassis must be handled using proper anti-static protection methods and must be packaged in anti-static packaging. Brooks Automation, Inc. / Granville-Phillips will supply return packaging materials at no charge upon request. Shipping damage on returned products as a result of inadequate packaging is the Buyer's responsibility.

## 1.8 FCC Verification

This equipment has been tested and found to comply with the limits for a Class A digital device, pursuant to Part 15 of the U.S. Federal Communications Commission (FCC) Rules. These limits are designed to provide reasonable protection against harmful interference when the equipment is operated in a commercial environment. This equipment uses and can radiate radio frequency energy and, if not installed and used in accordance with this instruction manual, may cause harmful interference to radio communications. However, there is no guarantee that interference will not occur in a particular installation. Operation of this equipment in a residential area is likely to cause harmful interference in which case the user will be required to correct the interference at his own expense. If this equipment does cause harmful interference to radio or television reception, which can be determined by turning the equipment OFF and ON, the user is encouraged to try to correct the interference by one or more of the following measures:

- Reorient or relocate the receiving antenna.
- Increase the separation between the equipment and the receiver.
- Connect the equipment into an outlet on a circuit different from that to which the receiver is connected.
- Consult the dealer or an experienced radio or television technician for help.

For information about FCC and EU compliance, see *FCC and EU Installation Requirements* on page 49.

The Series 358 Micro-Ion Vacuum Measurement System can operate one Micro-Ion gauge along with two Convectron Gauges simultaneously, or one Micro-Ion gauge along with one Convectron Gauge and one Capacitance Manometer Gauge simultaneously.

Pressure readout is via three front panel displays, analog output, and available computer interface.

The Series 358 Micro-Ion Vacuum Measurement Controller is a modular instrument that can easily be customized to fit most user's exact needs. Infrequently used controls are housed behind a hinged front panel, reducing front panel clutter and allowing the Controller to reside in a half rack space.

**Figure 2-1 Micro-Ion Vacuum Measurement System**

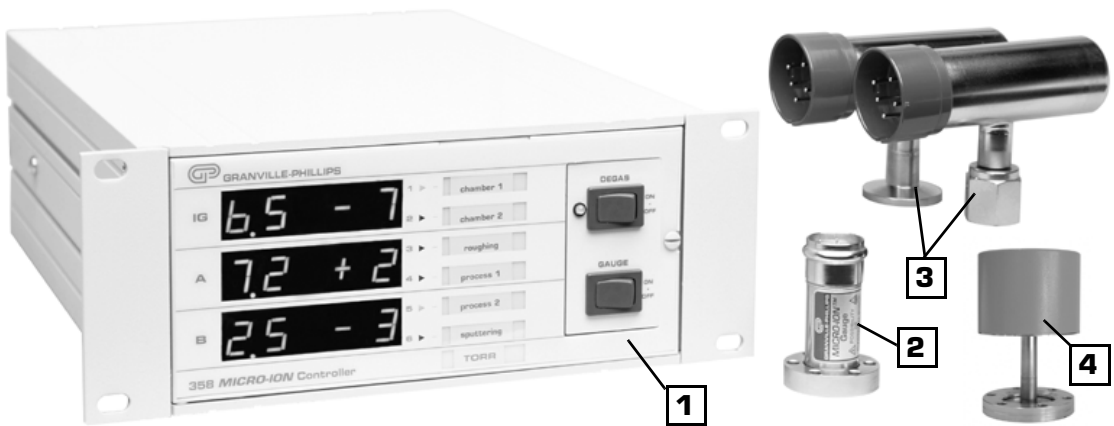

1. 358 Controller
2. Micro-Ion Gauge
3. Convectron Gauges
4. Capacitance Manometer Gauge

Figure 2-2 Controller Front Panel

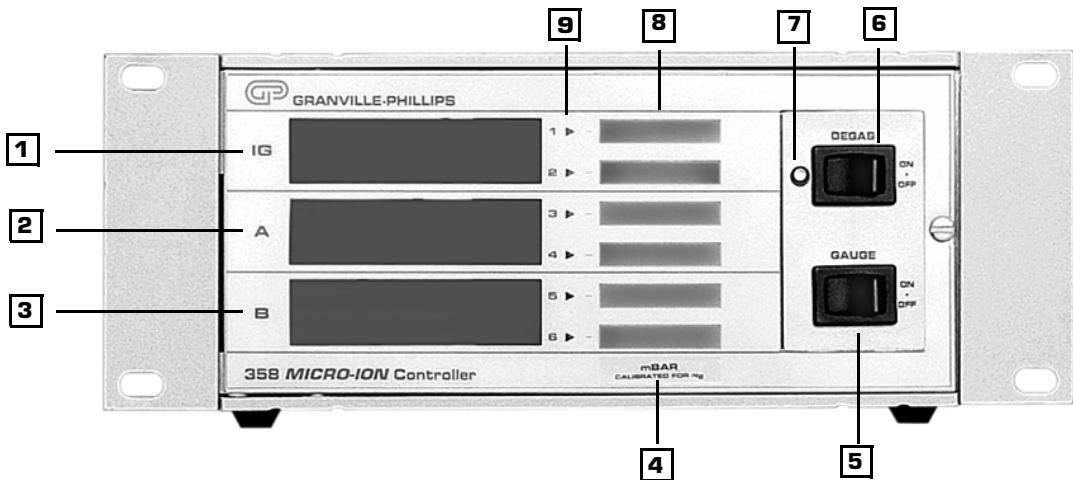

- 1. Micro-Ion display
- 2. Convectron Gauge A display
- 3. Convectron Gauge B or Capacitance Manometer display
- 4. Unit of measure label: Torr, mbar or pascal, user selectable
- 5. Micro-Ion Gauge “momentary” ON/OFF switch
- 6. Degas “momentary” ON/OFF switch
- 7. Degas LED
- 8. Process control channel labels
- 9. Process control channel indicator lights

Figure 2-3 Controller Front Panel with Door Open

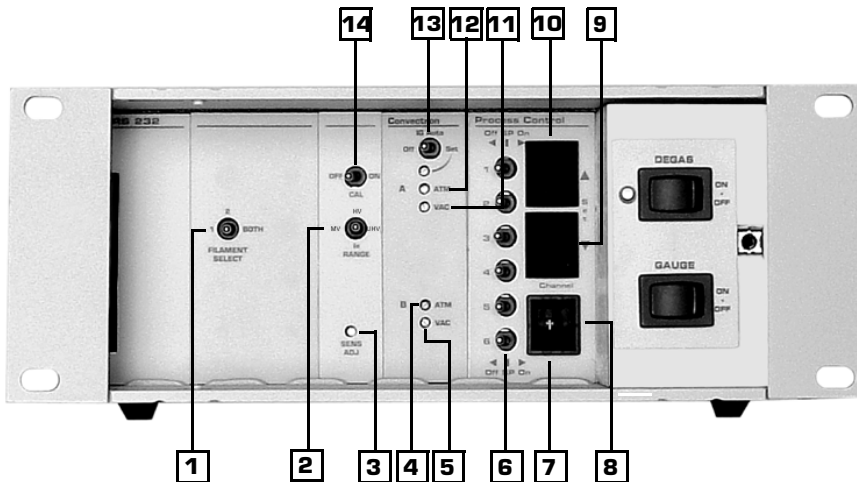

1. Filament select switch: filament 1, filament 2, or both
2. Pressure range selector
3. Sensitivity adjustment
4. Atmosphere adjustment, Convection or Capacitance Manometer gauge B
5. Vacuum zero adjustment, Convection or Capacitance Manometer gauge B
6. Process control setpoint 3-position manual override switches.  
Center = relay is controlled automatically.  
Left = relay is deactivated.  
Right = relay is activated.
7. Process control channel indicator
8. Process control channel selector thumbwheel
9. "Down" process control setpoint pressure set pushbutton
10. "Up" process control setpoint pressure set pushbutton
11. Vacuum zero adjustment, Convection gauge A
12. Atmosphere adjustment, Convection gauge A
13. Micro-Ion gauge auto ON switch (via Convection gauge)
14. Calibration / sensitivity ON switch

Figure 2-4 Controller Top View with Cover Removed

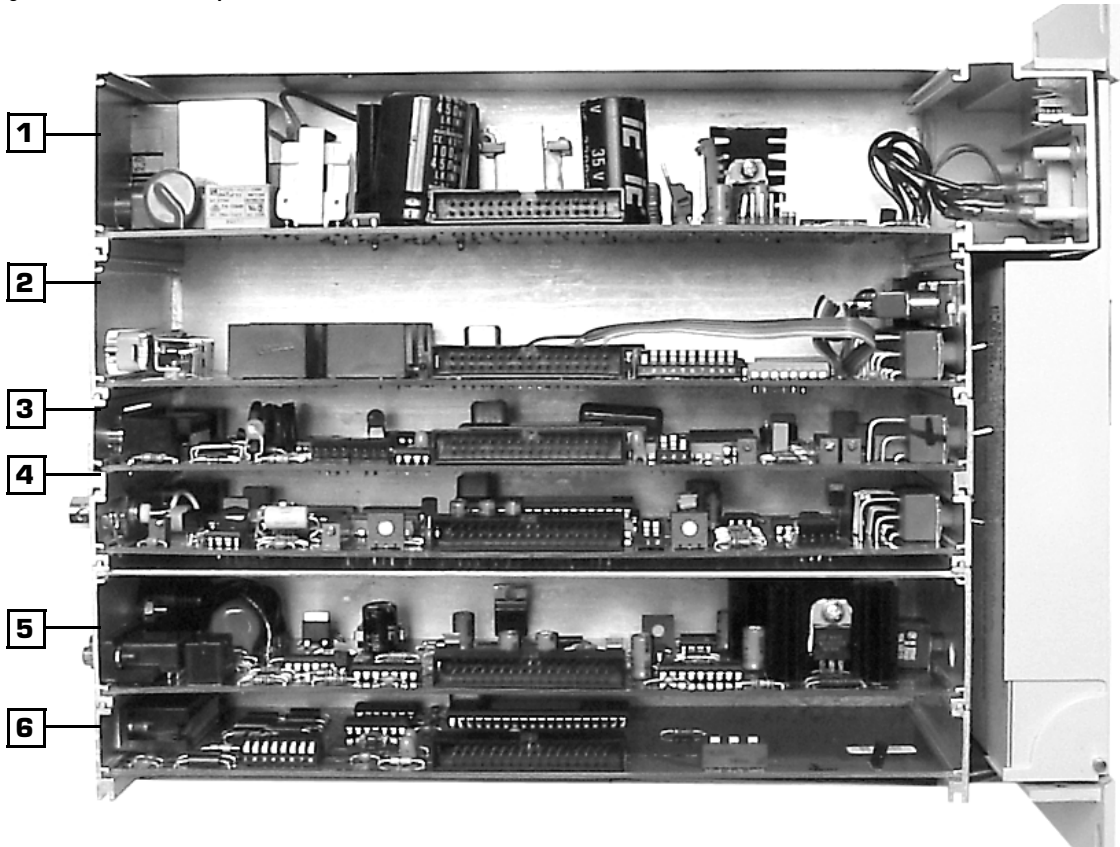

1. Power supply board
2. Process control setpoint option board
3. Convector or Capacitance Manometer gauge option board
4. Electrometer board
5. Filament/grid supply board
6. Interface option board (RS-232 or RS-485)



## 2.1 Options

### Process Control Relay

A 2-setpoint or 6-setpoint relay option can either be factory installed or added at any time by the user. The set points are adjustable from atmosphere to  $1 \times 10^{-10}$  Torr with override switches and front panel status indication.

### RS-232 or RS-485/422 Computer Interface Module

Provides readout of pressure, process control relay status, and Micro-Ion gauge control.

Figure 2-5 Controller Rear Panel (with RS-232 Option)

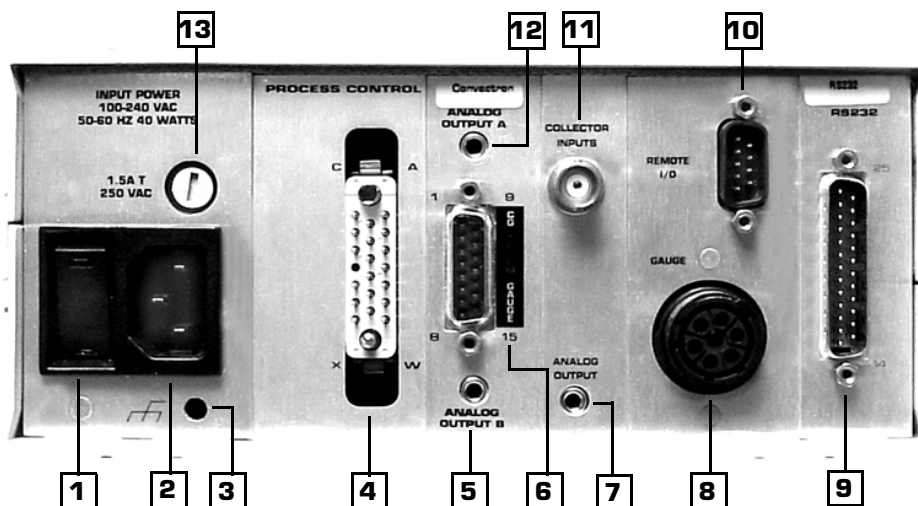

- |  |  |
|--|--|
| 1. Power switch  | 8. Micro-Ion gauge power connector                               |
| 2. Power input connector   | 9. DB25S connector for RS-232 computer interface                 |
| 3. Grounding lug to be connected to earth ground with 12 AWG conductor                 | 10. DE9S connector for remote parameter selection inputs/outputs |
| 4. 20-pin connector for process control relay contacts                                 | 11. Collector connector for Micro-Ion gauge                      |
| 5. Connector for analog output voltage from Convector or Capacitance Manometer gauge B | 12. Connector for analog output voltage from Convector gauge A   |
| 6. DA15P connector for Dual Convector or Capacitance Manometer gauge cable             | 13. Fuse holder  |
| 7. Connector for analog output voltage from Micro-Ion gauge                            |  |

2.2 RS-232 Specifications

Figure 2-6 RS-232 Wiring Connector

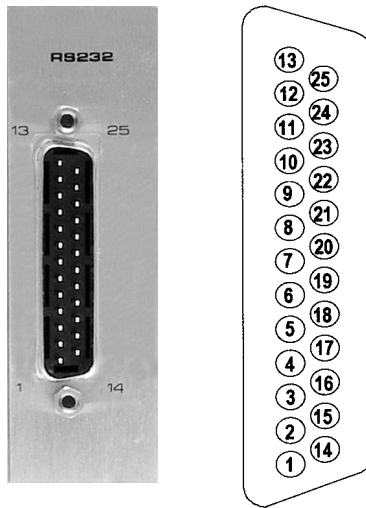

DB-25S connector

Table 2-1 RS-232 Specifications

Item	Specification
Format	EIA standard RS-232-C, half duplex, asynchronous
Data Rates	75,150,300,600,1200,2400,4800,9600 baud
Character length	7 or 8 bit ASCII, switch selectable
Parity	Odd, even, or none, switch selectable
Stop bits	1 or 2. 8 character bits plus parity allows only 1 stop bit
Handshake	Outputs: DTR,RTS. RTS polarity selectable. Inputs: DSR, CTS, DCD. May be forced to logic "TRUE" with switches
Logic levels	Inputs: Logic 1, 2.0 Vdc minimum, 15 Vdc maximum, logic 0, -15 Vdc minimum, 0.75 VDC maximum Input Current: 4.0 mA max @ Vin = +15 Vdc, -4.0 mA max @ Vin = -15 Vdc

2.3 RS-485 Specifications

Figure 2-7 RS-485 Wiring Connector

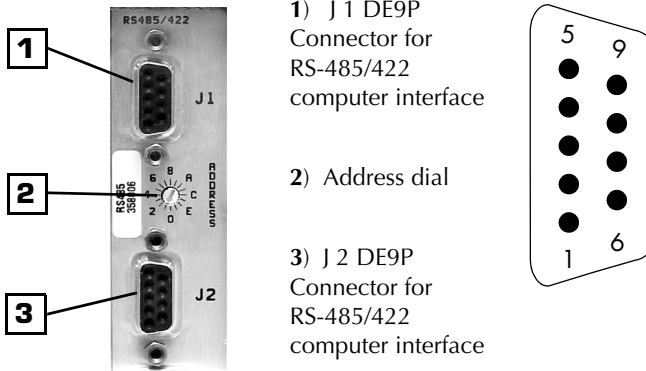

Table 2-2 RS-485 Specifications

Item	Specification
Format	Half duplex, asynchronous.
Data Rates	19200, 9600, 4800, 2400, 1200, 600, 300, 150 baud
Character Length	8 bit or 7 bit ASCII
Parity	No parity, even, or odd
Stop Bits	1 or 2
Handshake	None.
Address	256 selectable combinations
Number of Connections	Up to 32 devices
Total Cable Length	4000 ft. maximum

## 2.4 Specifications

Table 2-3 Specifications

Micro-Ion System	
Pressure Range for N <sub>2</sub> or air* Lower Measurement Limit Upper Measurement Limit	< 1 x 10 <sup>-9</sup> Torr (1.3 x 10 <sup>-9</sup> mbar) (1.3 x 10 <sup>-7</sup> pascal) at 4 mA emission Atmosphere
Controller	
Electronic accuracy	Typical ± 3% of reading at ambient temperature of 25 ± 5 °C
Display Units Update Rate	Digital, green LED, 2 digits plus exponent Torr, mbar, pascal (user selectable) 0.5 sec. typical as shipped. Internal switch selectable to 3 sec./reading averaged
Filament Control	Switch selectable: filament 1, filament 2, or both
Degas	Electron bombardment, approximately 4 W with 2 minute timer
Maximum Micro-Ion Gauge Cable Length	15 m (50 ft) with standard cable
Remote I/O Gauge and Degas On/Off Inputs  Filament Status Relay Contact Rating	Momentary ground controls filament selection and degas Less than 0.4 Vdc @ 10 µA for 25 msec (minimum). Must be greater than 3.5 Vdc for 105 msec (minimum) before next low state Micro-Ion gauge status relay rated at 1.0 A, 30 Vdc
Environment	Indoor use Altitude up to 2000 meters Temperature 0 °C to 40 °C Maximum relative humidity 80% for temperatures up to 31 °C decreasing linearly to 50% relative humidity at 40 °C Transient overvoltages according to installation category (overvoltage category) II Pollution degree 2 in accordance with IEC 664
Operating Temperature	0 °C to +40 °C ambient, noncondensing
Non-operating Temperature	-40 °C to +70 °C
Analog Output	0 to 10 Vdc, logarithmic, 1 V/decade
Overpressure Protection	Gauge turns OFF if pressure rises above factory set upper pressure limit
Emission Current Settings	0.02 mA (MV), 1 mA (HV), 4 mA (UHV)
Operating Voltage and Power	100 to 240 VAC, 50 to 60 Hz, 50 W maximum
Fuse Rating	250 V, 1.6 A, 5 x 20mm Time Lag (T), low breaking capacity
Weight	1.8 kg (4 lb)

\* Measurement limits are determined by the controller emission current setting and X-ray limit of the gauge.

**Table 2-3 Specifications**

<b>Controller Options</b>	
Process Control Relay Configuration Contact Rating Channels Hysteresis Setpoint adjustment	SPDT, Form C 5A @ 120 VAC, 4A @ 240 VAC resistive or 5A @ 30 Vdc 6 maximum, 2 per operating gauge maximum 10% Digital, 2 significant digits plus exponent
Digital Interfaces	RS-232 or RS-485/422
Dual Convectron Gauge Pressure Range Display Units Maximum Cable Length Analog Output Display Resolution	999 to $1 \times 10^{-4}$ Torr for N <sub>2</sub> or air Torr, mbar, pascal (user selectable) 150 m (500 ft) 0 to 7 V, logarithmic, 1 V/decade, adjustable offset of +1 to -7 Vdc 2 significant digits, except for lowest two decades
<b>Micro-Ion Gauge</b>	
Sensitivity	3/Torr to 50/ Torr (factory setting is 20/Torr)
Emission Current	20 $\mu$ A, 1 mA, 4 mA
Collector Potential	0 V
Grid Potential	+180 Vdc
Filament Potential	+30 Vdc
Degas	Electron bombardment: 15 mA DC, 250 Vdc, auto shutoff, 2 minutes
Analog Output	0 to 10 Vdc, logarithmic, 1 V/decade
Filaments	Dual yttria-coated iridium, or tungsten <sup>†</sup>
Operating Temperature	0 °C to +50 °C ambient, noncondensing
Gauge Bakeout Temperature	+200 °C maximum
Cable Bakeout Temperature	+150 °C maximum
Materials Exposed to Vacuum	Vacuum fired, UHV compatible
Internal Volume	10.8 cm <sup>3</sup> (0.66 in. <sup>3</sup> )
Weight	0.1 kg (4 oz.) (with 1 5/16 in. Conflat <sup>®</sup> type flange)

<sup>†</sup> Tungsten filaments are for applications involving gases containing fluorine, chlorine, or other gas species that poison yttria-coated iridium filaments. Tungsten filaments are not recommended for general vacuum applications because they may burnout when exposed to high pressures.

**Table 2-3 Specifications**

<b>Convectron Gauge</b>	
Pressure Range	$1 \times 10^{-4}$ Torr to 990 Torr, N <sub>2</sub> equivalent
Display Resolution	2 significant digits, except for 1 significant digit in $1 \times 10^{-4}$ Torr decade
Gas Type	N <sub>2</sub> , air (for direct reading)
Display Update Time	0.5 sec. typical. Switch selectable to 3 sec./reading, averaged
Analog Output	0 – 7 Vdc, logarithmic, 1 V/decade
Ion Gauge Turn-On Range	Less than or equal to 100 mTorr ( $1 \times 10^{-1}$ Torr)
Sensor Material	Gold-plated tungsten
Mounting Orientation	Gauge axis must be horizontal to provide accurate measurement above about 1 Torr
Operating Temperature	+4 °C to +50 °C ambient, noncondensing
Bakeout Temperature	+150 °C maximum, nonoperating, cable disconnected
Cable Bakeout Temperature	+105 °C maximum
<b>Ion Gauge Pressure Range*</b> See Table 3-1 on page 30	

**Table 2-3 Specifications**

Capacitance Manometer	
Gauge Type	Any capacitance manometer transducer that requires $\pm 15$ Vdc power at $< 250$ mA and outputs 0–10 Vdc proportional to pressure
Accuracy	0.01% of full scale (as limited by display resolution)
Display Resolution	Highest 3 decades – 2 digits, lowest decade – 1 digit, scientific notation
Maximum Pressure Scales	1, 10, 100, 1000 Torr max heads, 4 decades of pressure
Display Update Time	Unfiltered: 0.5 sec. typical. Switch selectable filtering: 3 sec. (average of 6 readings)
Output to Head	$\pm 15$ V $\pm 2\%$ at 250 mA
Input from Head	0 to 10 Vdc into 100 k $\Omega$
Analog Output	5 mA maximum
Analog Output Speed	Limited by transducer speed
Cable Connection	Cable termination is bare tinned wire, user terminates to transducer

## 2.5 Dimensions

The dimensions of the controller in a half rack (standard) mounting are shown in Figure 2-8.

Dimensions are in centimeters (inches).

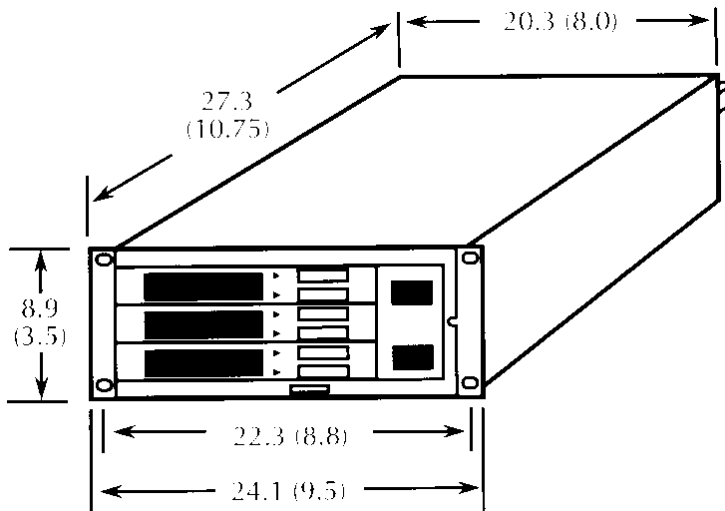
**Figure 2-8 Controller Dimensions**

The dimensions of the Micro-Ion gauge are shown in Figure 2-9.  
 Dimensions are in cm (in.).  
 H dimensions are given in Table 2-4.

**Figure 2-9 Micro-Ion Gauge with Connector**

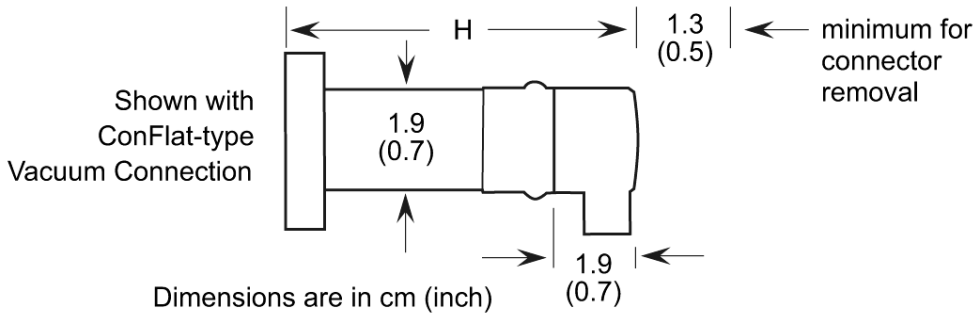

The dimensions of the Convectron gauge are shown Figure 2-10.  
 Dimensions are in cm (in.).  
 J dimensions are given in Table 2-4.

**Figure 2-10 Convectron Gauge with Connector**

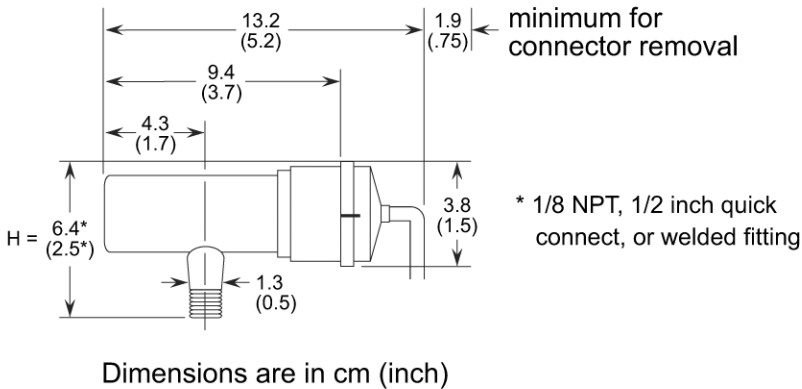
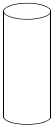
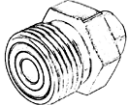





Table 2-4 Fittings

Fitting	Description	Dimension H	Dimension J
	0.75 inch port diameter 1.0 inch port diameter 15 mm port diameter 18 mm port diameter	9.4 cm (3.7 in.) 9.4 cm (3.7 in.) 9.4 cm (3.7 in.) 9.4 cm (3.7 in.)	Not applicable Not applicable Not applicable Not applicable
	1/4 inch VCR® type 1/2 inch VCR type	Not applicable 8.6 cm (3.4 in.)	8.1 cm (3.2 in.) 8.1 cm (3.1 in.)
	NW16KF flange NW25KF flange NW40KF flange	7.3 cm (2.9 in.) 7.3 cm (2.9 in.) 7.3 cm (2.9 in.)	6.9 cm (2.7 in.) 6.9 cm (2.7 in.) Not applicable
	1.33 inch ConFlat® 2.75 inch ConFlat	7.3 cm (2.9 in.) 7.3 cm (2.9 in.)	6.4 cm (2.5 in.) 6.4 cm (2.5 in.)

VCR® is a registered trademark of Swagelok Company; ConFlat® of Varian, Inc.

## 2.6 Mounting Options

The controller can be ordered with a variety of mounting options to fit your needs. This includes half rack (standard), full rack, or two units in a full rack. See *Controller Installation* on page 50 and Figure 4-1 on page 52.



### 3.1 Controller Setup

Now is a convenient time to make any required switch changes before mounting the Controller in its desired location.

If the pressure display units of measure are correct (see Figure 3-1), and you do not want to change the degas power timer from the factory setting of 10 minutes, skip to *Process Control Setup* on page 32.

Figure 3-1 Units of Measure Label

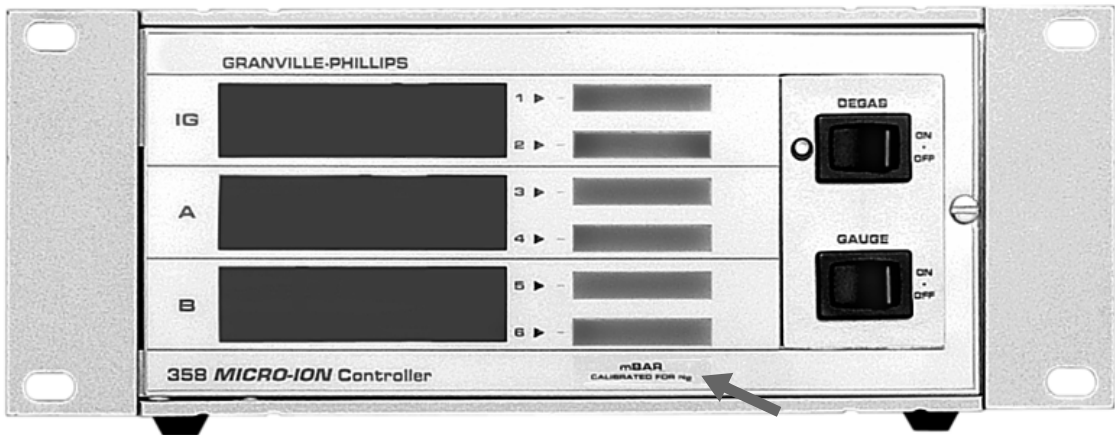

If you want to change the units of measure, the display rate, or the degas timer, you must remove the top cover of the Controller.

### 3.2 Top Cover Removal

1. With power OFF, remove any cables from Controller rear panel.
2. Observe antistatic precautions to avoid damaging static sensitive components inside the chassis. Use a grounded, conductive work surface. Do not handle integrated circuits (IC) devices more than necessary, and only when wearing a high impedance ground strap. (A high impedance helps protect human life in case of inadvertent contact with high voltage.)
3. Remove the four Phillips head screws identified in Figure 3-2. If the unit is equipped with a rear bracket, remove the Phillips head screw on the bracket, and slide the bracket off.

Figure 3-2 Location of Screws for Top Cover Removal

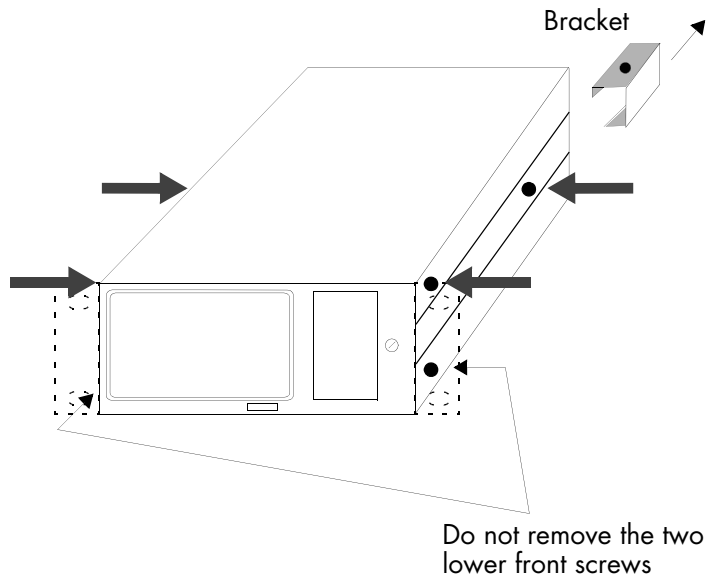

### 3.3 Pressure Units Setup

If units of measure are as desired (see Figure 3-1), skip to *Changing Display Update Rate on Electrometer Module* on page 30.

### 3.4 Changing Units of Measure for Electrometer Module

Your unit will have been shipped from the factory preset to display the unit of measure, Torr, mbar, or pascal, that you requested. Selection between Torr and mbar units is done by adjusting the Micro-Ion gauge tube sensitivity to the appropriate units. For example, a tube has a sensitivity of 20/Torr or 15/mbar. Thus, for this tube, adjusting the sensitivity for a display reading of 2.0+1 will result in display of pressure in Torr (see *Sensitivity Adjustment* on page 99). Adjusting to 1.5+1 will result in display in mbar. If you want to change pascal units, change the switch on the electrometer module as follows:

1. Shut OFF power to the Controller.
2. Remove the top cover as described in *Top Cover Removal* on page 27.
3. Locate the Micro-Ion gauge electrometer module. See Figure 2-4 and Figure 3-3.
4. Locate the Unit of Measure display units control switch.

Figure 3-3 Ion Gauge Electrometer Module TopView

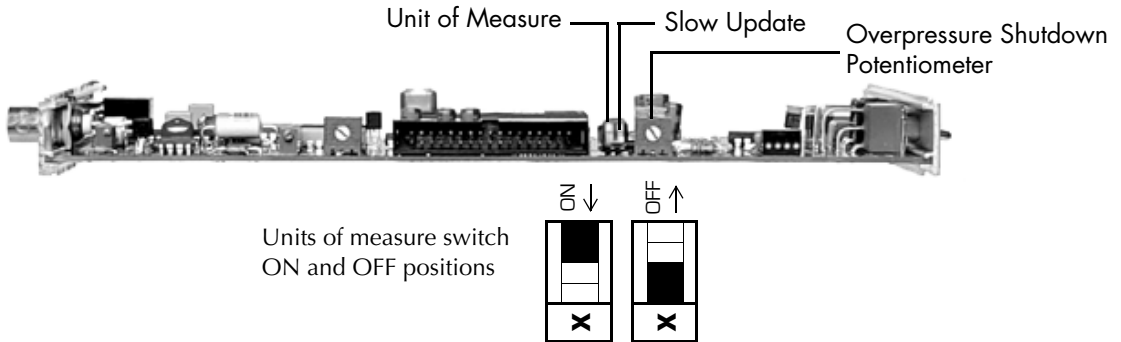

- Set the switch to the desired position: Off = Torr/mbar units; On = pascal units.

You must also change the setting of the unit of measure switch on the Dual Convectron gauge as described in *Changing Units of Measure for Convectron Gauge* on page 30.

- To change the units of measure label on the front of the Controller, open the door and lift the label card from its slot in the top of the panel. Units of measure labels are included in the mounting hardware kit.

Figure 3-4 Removing the Units of Measure Label Card

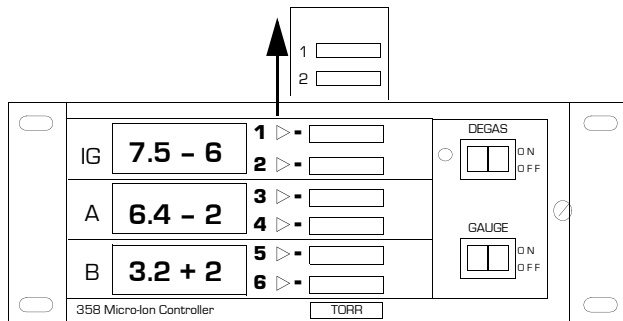

- 3.5 Overpressure Shutdown Adjustment** This control is factory set so the ion gauge will shut down when the pressure rises above the levels given in Table 3-1.

**Table 3-1 Pressure Range Settings**

Pressure Range Designation	MV (Medium Vacuum)	HV (High Vacuum)	UHV (Ultrahigh Vacuum)
Emission Current	20 $\mu$ A	1 mA	4 mA
Recommended Upper Limit, Torr	$5 \times 10^{-2}$	$8 \times 10^{-4}$	$2 \times 10^{-4}$
Recommended Lower Limit, Torr	$1 \times 10^{-6}$	$1 \times 10^{-7}$	Less than $1 \times 10^{-9}$

To adjust the overpressure shutoff point to a different level:

1. Maintain system pressure at the desired shutoff point.
2. Rotate the overpressure adjustment potentiometer fully counterclockwise.
3. Turn ON the ion gauge.
4. Rotate the adjustment potentiometer clockwise slowly until the ion gauge turns OFF.

- 3.6 Changing Display Update Rate on Electrometer Module** When "ON", the Slow Update switch on the electrometer module enables pressure averaging. The display will be updated approximately every 3 seconds. When "OFF", the update period is approximately 0.5 seconds. Refer to Figure 3-3 on page 29.

- 3.7 Changing Units of Measure for Convector Gauge** The Series 358 Controller is shipped from the factory preset to display the units of measure, Torr, mbar, or pascal, that you requested. To change the units of measure for the Convector Gauge:
1. Turn OFF power to the Controller.
  2. Remove the top cover as described in *Top Cover Removal* on page 27.
  3. Locate the Convector gauge module. See Figure 2-4 and Figure 3-5.
  4. Locate the mbar and pascal units switches.
  5. Leave both switches "OFF" for Torr units. Turn ON the switch for either mbar or pascal units.
  6. Modify the units of measure of the electrometer module to be consistent with the Convector gauge. (See *Changing Units of Measure for Electrometer Module* on page 28.)
  7. Slip the label card out of the top of the front panel and apply the appropriate pressure units label. See Figure 3-4.
  8. Replace the top cover as described on page 47.

Figure 3-5 Convectron Gauge Module Top View

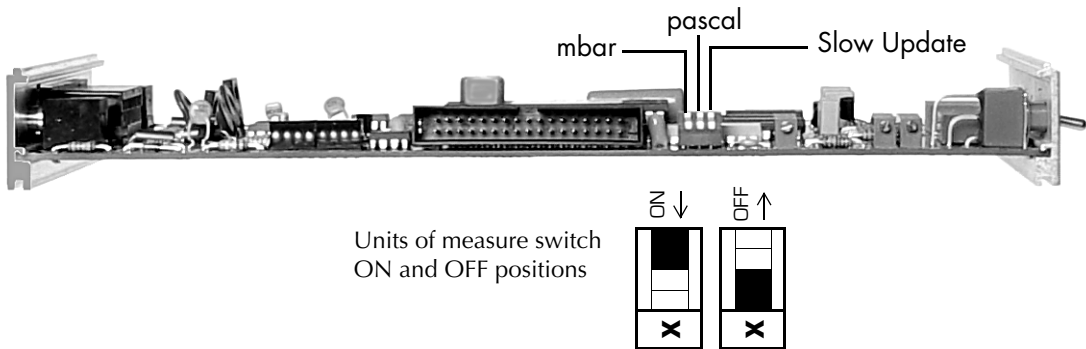

### 3.8 Display Update Rate Switch on Convectron Module

When "ON", this the Slow Update switch on the Convectron module enables pressure averaging. The display will be updated approximately every 3 seconds. When "OFF", the update period is approximately 0.5 seconds. Refer to Figure 3-5.

### 3.9 Changing Units of Measure for a Capacitance Manometer

The Series 358 Controller is shipped from the factory preset to display the units of measure, Torr, mbar, or pascal, that you requested. If you want to change units, proceed as follows:

1. Turn OFF power to the Controller.
2. Remove the top cover as described in *Top Cover Removal* on page 27.
3. Locate the Capacitance Manometer gauge module. See Figure 2-4 and Figure 3-6.

Figure 3-6 Capacitance Manometer Gauge Module Top View

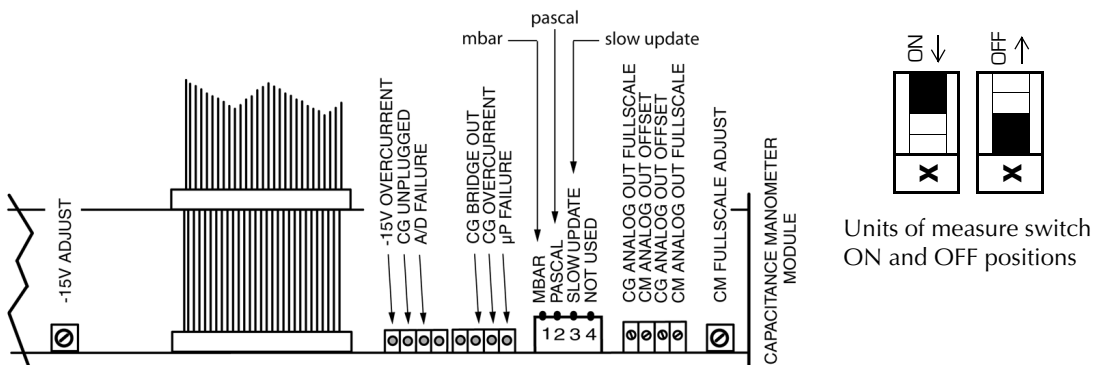

4. Locate the mbar and pascal units switches.
5. Leave both switches "OFF" for Torr units. Turn ON the switch for either

mbar or pascal units.

6. Modify the units of measure of the electrometer module to be consistent with the Capacitance Manometer gauge. (See *Changing Units of Measure for Electrometer Module* on page 28.)
7. Slip the label card out of the top of the front panel and apply the appropriate pressure units label (see Figure 3-4 on page 29).
8. Replace the top cover as described in *Replacing the Controller Cover* on page 47.

### 3.10 Process Control Setup

 **CAUTION**

**Failure to check system programming before switching to automatic operation can cause measurement error.**

To avoid measurement error due to inaccurate output signals, carefully check the system programming before switching to automatic operation.

 **WARNING**

**Failure to install appropriate pressure relief devices for high-pressure applications can cause product damage or personal injury.**

For automatic backfilling and other applications in which malfunction or normal process conditions can cause high pressures to occur, install appropriate pressure relief devices.

A process control module provides the controller with single-pole, double-throw relays that may be controlled either by digital setpoints or by the built-in manual override switches.

#### **Process Control Channel Identification Windows**

A channel identification label is included in the accessory kit to enable you to customize your controller for your application (see Figure 3-7).



Figure 3-7 Process Control Identification Windows

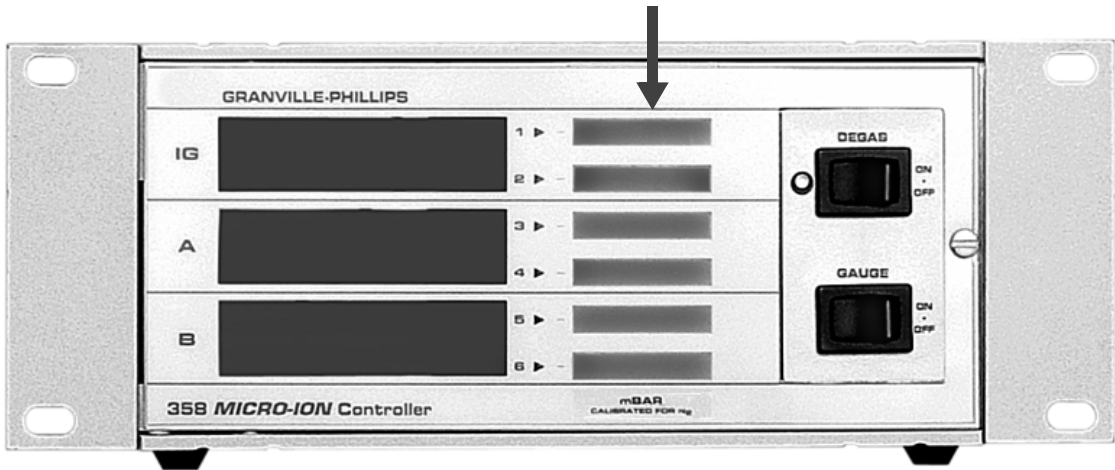

#### Developing a Logic Diagram of Control Logic

Prior to connecting the process controls to the system, it is recommended that the following steps be followed. If application assistance is desired, contact a Brooks Automation Inc./Granville-Phillips application engineer.

1. Use the catalog number on the front of the process control module together with Figure 3-8 and Figure 3-9 to identify the process control capability installed in your unit.
2. Even if the control logic is simple and obvious, we recommend that you develop a logic diagram of the process control function.
3. Prepare a specification table which lists the proposed pressure setting, system measurement point, and relay status for each process control channel.
4. Draw a circuit schematic which specifies exactly how each piece of system hardware will be connected to the process control relays.

Do not exceed the relay ratings:

Table 3-2 Relay Ratings

Parameter	Rating
Relay Configuration	SPDT (single pole, double throw)
Relay Contact Rating	5 A, 120 VAC; or 4A, 240 VAC; or 5A, 30 Vdc
Relay Contact Type	1 Form C type (gold plated for low level switching)

If the relay contacts are used to switch high currents, the gold plating may be consumed. This may make the contacts unsuitable for low level signal switching in the future.

5. Attach a copy of the process control circuit diagram to this manual for future reference and troubleshooting.
6. The required process control connections may be made later. (See *Connecting Process Control Relays* on page 63.)
7. If application assistance is desired, contact a Brooks Automation Inc./Granville-Phillips application engineer.

**Figure 3-8 2-Channel Process Control Option Card**

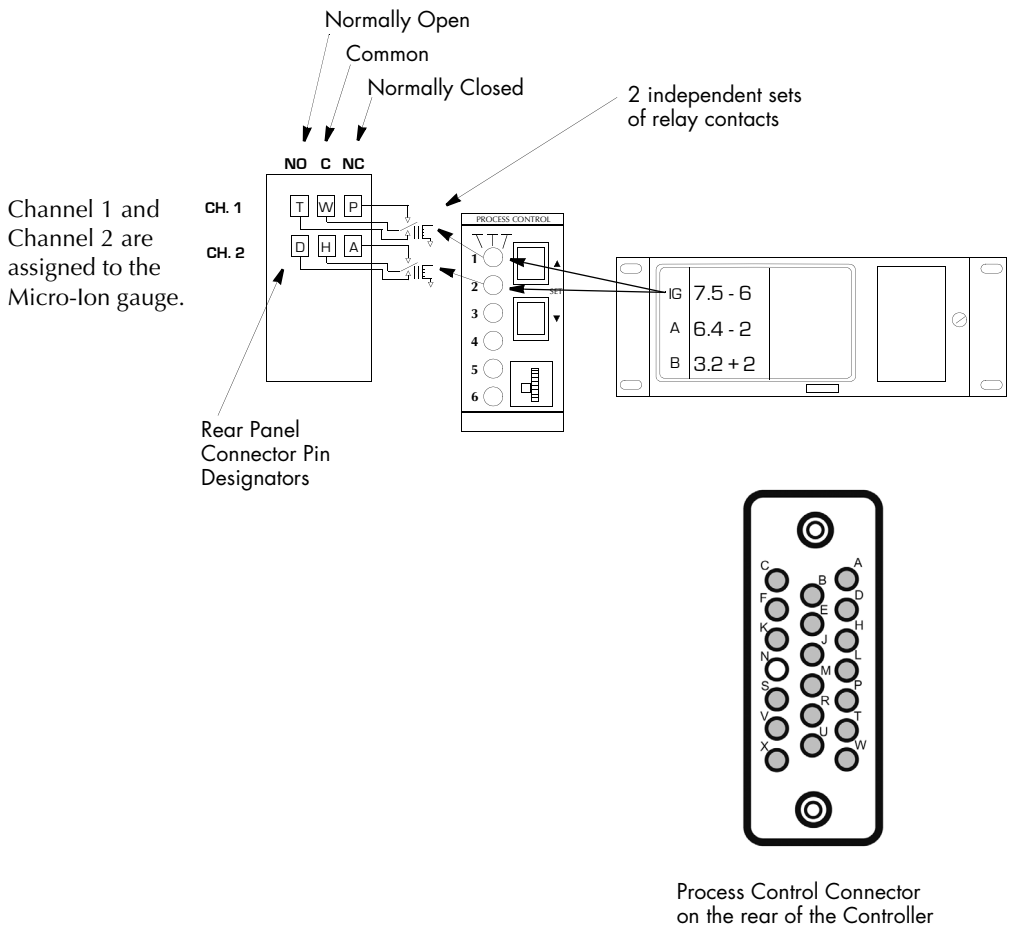
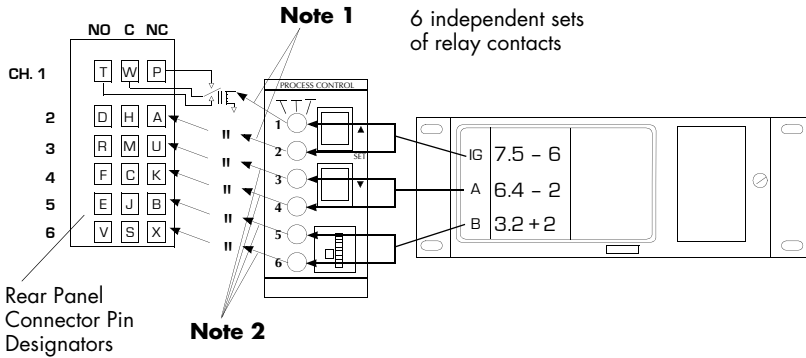

Figure 3-9 6-Channel Process Control Option Card



Channel 1 and Channel 2 are assigned to the Micro-Ion Gauge.

Channels 3 and 4 are factory assigned to Convectron Gauge A.

Channels 5 and 6 are factory assigned to Convectron Gauge B or capacitance manometer gauge B.

3.11 Relay Polarity Setting

The relays can be set to activate as pressure either rises above or falls below the setpoint. A DIP switch is provided for each channel. Refer to the numbers on the printed circuit board (not on the switch body) for the channel number. Use Table 3-3 to assign relay polarity settings.

The switches are factory preset as shown below for relay activation below the pressure setpoint. This is most commonly desired when you want the relay to be de-energized under a high pressure condition.

Figure 3-10 Process Control Relay Polarity Switches

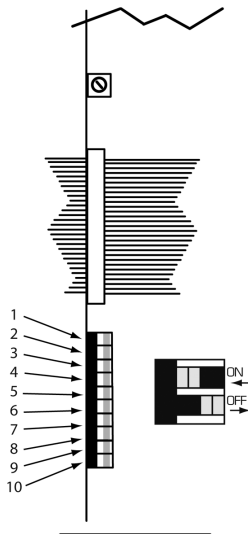

**Table 3-3 Relay Polarity Switch Settings**

Switch Settings	Channel Activated	Pressure Indication Relative to Setpoint	Switch Settings	Channel Activated	Pressure Indication Relative to Setpoint
	6	Below (factory setting)		3	Below (factory setting)
	6	Above		3	Above
	5	Below (factory setting)		2	Below (factory setting)
	5	Above		2	Above
	4	Below (factory setting)		1	Below (factory setting)
	4	Above		1	Above

**Process Control Tips**

1. The process control override switches can be used to hold relays ON or OFF during initial setup or during non-typical process conditions.
2. When the Micro-Ion gauge is OFF, channels 1 and 2 are inoperative.
3. When Convectron gauges are disconnected, channels 3 through 6 are inoperative.
4. The status of relays 1 and 2 will not change during degas. The controller pressure will remain at the reading when degas began.
5. Relay actuation occurs when the pressure indication differs from the setpoint value by one display unit. A 10% hysteresis is automatically programmed into each setpoint for returning pressures. Table 3-4 exemplifies this using a setpoint pressure of  $6.3 \times 10^{-7}$ , and assuming the polarity is set for falling pressure activation.

**Table 3-4 Setpoint Hysteresis**

Setpoint Pressure	Pressure Change	Relay Actuation Pressure
$6.3 \times 10^{-7}$	Falling	$6.2 \times 10^{-7}$
$6.3 \times 10^{-7}$	Rising	$6.3 \times 10^{-7} + 10\% = 7.0 \times 10^{-7}$

**3.12 RS-232 Computer Interface Setup**

If your Controller does not have this capability, skip to *RS-485 Computer Interface Setup* on page 42.

This available capability permits data output to, and gauge control by, a host computer. Output is either by a command-response mechanism or by a talk-only mode which is invoked via a switch on the RS-232 board. If you have this module in your unit, configure it to your system requirements by setting the switches as instructed in *Selecting Byte Format for RS-232 Module* on page 39.

A variety of baud rates and byte framing options are available, as well as switches to force the handshake lines to an “always true” condition.

Controller RS-232 factory defaults are: 9600 BAUD, 8 data bits, no parity, 1 stop bit; DCD, CTS, DSR forced “true”.

The interface protocol is set using 8 switches.

Internal switches are read upon controller power up. Changes in settings will take effect upon next power-up cycle.

**Connector Pinouts for RS-232 Computer Interface**

This factory or field-installed option has pin functions as shown in Table 3-5.

A mating DB-25S connector is supplied in the hardware kit. Use shielded cable to minimize electromagnetic radiation or susceptibility.

**Figure 3-11 RS-232 Connector**

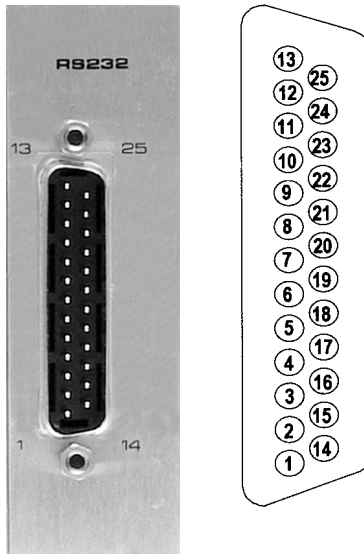

DB-25S connector

**Table 3-5 RS-232 Connector Pin Assignments**

Signal	Pin Number	Direction
Protective Ground	1	–
Transmitted Data	2	To computer
Received Data	3	To controller
Request to Send (RTS)	4	To controller
Clear to Send (CTS)	5	To controller
Data Set Ready (DSR)	6	To controller
Signal Ground (common return)	7	–
Data Carrier Detect (DCD)	8	To controller
Data Terminal Ready (DTR)	20	To computer

**Selecting Byte Format for RS-232 Module**

**Baud Rate for RS-232 Module**

Dip switches 6-8 are used to control the baud rate. The settings are listed in Table 3-6.

**Figure 3-12 RS-232 Module Top View**

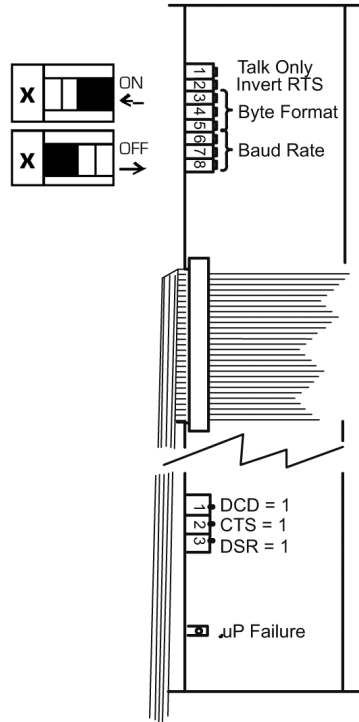

**Table 3-6 RS-232 Baud Rates**

S6	S7	S8	Baud Rate
On (factory setting)	On (factory setting)	On (factory setting)	9600 (factory setting)
On	On	Off	4800
On	Off	On	2400
On	Off	Off	1200
Off	On	On	600
Off	On	Off	300
Off	Off	On	150
Off	Off	Off	75

**Character Framing for RS-232 Module**

Switches 3-5 control the number of characters, parity, and number of stop bits.

**Table 3-7 RS-232 Character Framing**

S3	S4	S5	Character Bits	Parity	Stop Bits
On (factory setting)	On (factory setting)	On (factory setting)	8 (factory setting)	None (factory setting)	1 (factory setting) or 2
On	On	Off	8	Even	1
On	Off	On	8	Odd	1
On	Off	Off	8	None	1
Off	On	On	7	Even	1
Off	On	Off	7	Odd	1
Off	Off	On	7	Even	2
Off	Off	Off	7	Odd	2

**Talk-Only Mode for RS-232 Module**

Switch S1, if OFF at power-up, puts the interface in talk-only mode. The pressure data from all three displays will be output in a single message string, separated by commas, approximately every 5 seconds.

**Table 3-8 RS-232 Talk-Only Mode**

S1	Mode
Off	Talk-only
On	Command-response (factory setting)



**Handshake Line Control  
Switches for RS-232  
Module**

Refer to *Connecting the RS-232 Computer Interface Handshake Lines* on page 65 for more detailed information on the handshaking mechanism.

**Table 3-9 RS-232 Handshake Line Control Switches**

Line	Switch	Description	Internal Switch Function	Factory Setting
CTS	2	CLEAR to SEND and DATA SET READY: When used, both must be TRUE in order for controller to send the next byte in its message or data.	CTS=1 and DSR=1: When ON, forces the functions TRUE and thus assumes host is always ready to receive.	Both ON (factory setting)
DSR	3			
DCD	1	DATA CARRIER DETECT: Must be TRUE at the time each character is received or that character will be ignored by controller.	DCD=1: When ON, forces DCD function TRUE so controller will receive all characters sent to it (as long as RTS is in de-asserted state).	ON (factory setting)

**Invert RTS Switch for  
RS-232 Module**

As shipped from the factory, the request-to-send (RTS) control line is set to operate as a modem line per the RS-232 standard. In some implementations it is necessary to invert this line and hook it directly to the clear-to-send (CTS) line of the host computer. Switching S2 to OFF tells the RS-232 interface to invert the polarity of the RTS line when the controller goes through its power-up sequence. See *Connecting the RS-232 Computer Interface Handshake Lines* on page 65 for more details.

When the controller receives a start bit on the received data line, it will input and buffer a character. The controller will continue to receive and buffer characters until the terminator (LF) is received.

**Table 3-10 RS-232 Controller Outputs**

Line	Pin	Description	Internal Switch Function	Factory Setting
RTS	2	REQUEST TO SEND: De-asserted by controller on power-up. Asserted by controller upon receipt of a message terminator as a holdoff to prevent the host computer from attempting to transmit data until the message just received has been parsed and a reply has been output. De-asserted after transmitting the terminator of controller's response to that message.	INVERT RTS: When OFF inverts the polarity of the RTS line allowing nonstandard connection directly to host computer CTS line. When ON, set to operate as a modem line per RS-232 standard.	ON

**3.13 RS-485 Computer Interface Setup**

If your Controller does not have this capability, skip to *Replacing the Controller Cover* on page 47.

RS-485 capability permits data output to, and gauge control by, a host computer. Output is by a command-response mechanism. If you have this module in your unit, configure it to your system requirements by setting the switches as instructed in *Selecting Byte Format for RS-485 Module* on page 46.

A variety of baud rates and byte framing options are available, as well as switches to force the handshake lines to an “always true” condition.

The controller RS-485 factory defaults are: 19.2Kbd, 8 character bits, no parity, 1 stop bit, address = 01.

Internal switches are read upon controller power up. Changes in settings will take effect upon next power-up cycle.

**Connector Pinouts for RS-485 Computer Interface**

Connectors J1 and J2 on the rear panel are wired in parallel and are interchangeable. Connection can easily be made by “daisy chaining” gauge Controllers together with the signal from the host computer going into one connector then out the other to another gauge Controller, and so on.

The maximum total cable length is 4,000 ft. No more than 32 devices can be connected to one RS-485 communications line. When an RS-485 network is in an idle state, all nodes are in listen (receive) mode. Under this condition there are no active drivers on the network. To maintain the proper idle voltage state, bias resistors must be applied to force the data lines to the idle condition. Figure 3-16 illustrates the placement of bias resistors on a host computer, 2-wire configuration, for the typical 5 volt and 24 volt systems.

Figure 3-13 RS-485 Bias Resistors

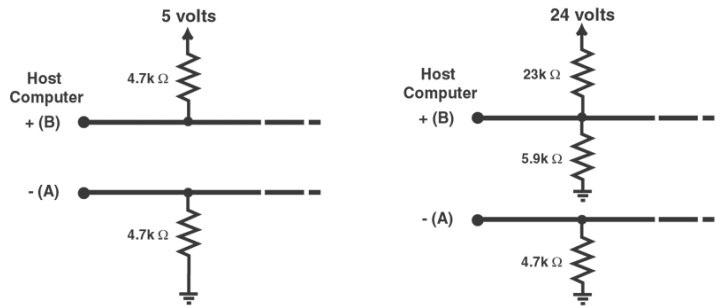

Figure 3-14 RS-485 Wiring Connector

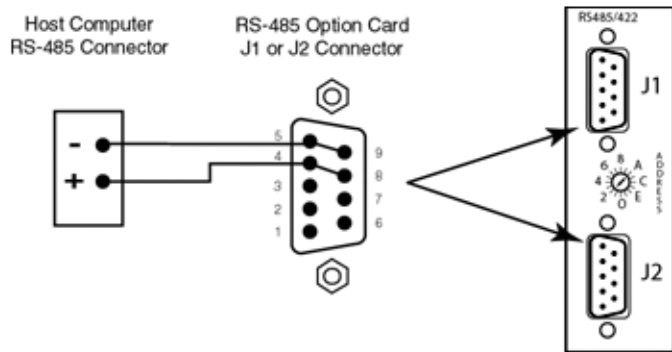

Table 3-11 RS-485 Connector Pins

Signal	Pin Number
+TX	4
-TX	5
+RX	8
-RX	9
Ground	3

1. Connect TX on the gauge Controller to RX on the host computer and connect RX on the gauge Controller to TX on the host computer.
2. Connect TX to TX and RX to RX on all controllers. If the computer sends and receives data on 2 wires, connect +TX to +RX and connect -TX to -RX.
3. The polarity may have to be reversed on the computer and other instruments—you may have to try it both ways. No damage will result if connections are wrong.

The timing of the data transfer is shown in Figure 3-15.

**Figure 3-15 RS-485 Data Timing**

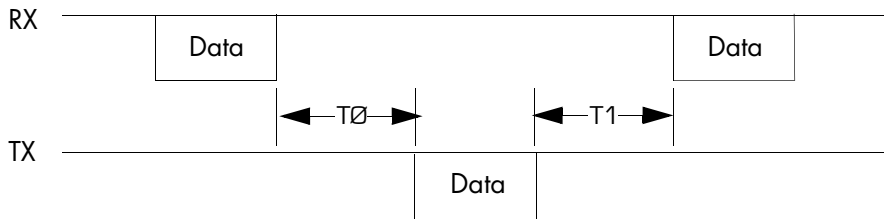

$T0 = 10 \text{ to } 13 \text{ mS} + 10 \text{ bits with S2.1 OFF.}$   
 $T0 = 700 \text{ } \mu\text{S with S2.1 ON.}$   
 $T1 = 300 \text{ } \mu\text{S minimum.}$

**RS-485 Address**

The address switch on the RS-485 module on the back of the Controller (see Figure 3-14) and Switch S1 (see Figure 3-16) determine the RS-485 module's address. This address can be any hex code from 00 to FF.

The address switch on the RS-485 module on the back of the Controller determines the value of the least significant digit and S1 determines the value of the most significant digit. S1 switch positions are binary. The weights of switches when OFF are listed in Table 3-12.

Figure 3-16 RS-485 Module - Top View

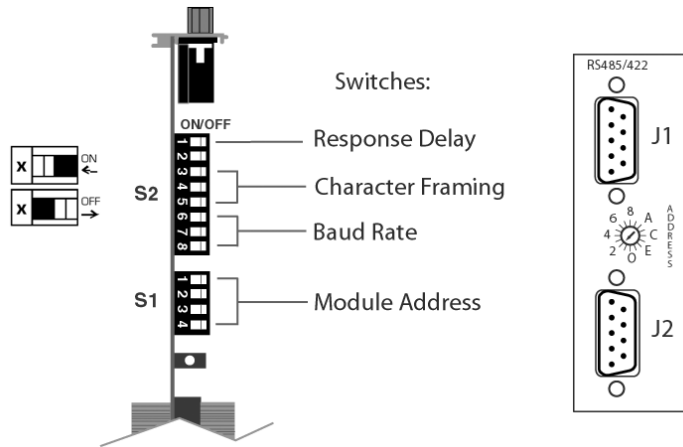

Table 3-12 RS-485 Switch Weight when S1 Switches are set to OFF

S1	Weight
S1.1	10 <sub>hex</sub>
S1.2	20 <sub>hex</sub>
S1.3	40 <sub>hex</sub>
S1.4	80 <sub>hex</sub>

- To prevent data contentions, no two of the controller modules should be set with the same address.
- It is not recommended that address 00 be used because some manufacturers use this address for configuration.

**Selecting Byte Format for RS-485 Module**

**Baud Rate for RS-485**

Baud rate for the RS-485 computer interface is determined by S2.6, S2.7, S2.8.

**Table 3-13 RS-485 Baud Rates**

S2.6	S2.7	S2.8	Baud Rate
On	On	On	19200 (factory setting)
On	On	Off	9600
On	Off	On	4800
On	Off	Off	2400
Off	On	On	1200
Off	On	Off	600
Off	Off	On	300
Off	Off	Off	150

**Character Framing for the RS-485 Computer Interface**

Character framing for the RS-485 computer interface is determined by S2.3, S2.4, S2.5.

**Table 3-14 RS-485 Character Framing**

S2.3	S2.4	S2.5	Character Bits	Parity	Stop Bits
On	On	On	8	None	2
On	On	Off	8	Even	1
On	Off	On	8	Odd	1
On	Off	Off	8 (factory setting)	None (factory setting)	1 (factory setting)
Off	On	On	7	Even	1
Off	On	Off	7	Odd	1
Off	Off	On	7	Even	2
Off	Off	Off	7	Odd	2

**Response Delay for the RS-485 Computer Interface**

Switch S2.1 (Figure 3-16 on page 45) enables a delay in the response from the module of 13 MS + 10 bits when OFF. When S2.1 is ON the delay is 700 µS. Default is ON.

**3.14 Replacing the Controller Cover**

Assuming you have completed the above instructions, the Controller setup is now complete. Replace the top cover. Make sure the door hinge pin is seated correctly. Replace the four top cover Phillips head screws and the side-by-side clamp, if used.

**Figure 3-17 Location of Screws for Replacing the Top Cover**

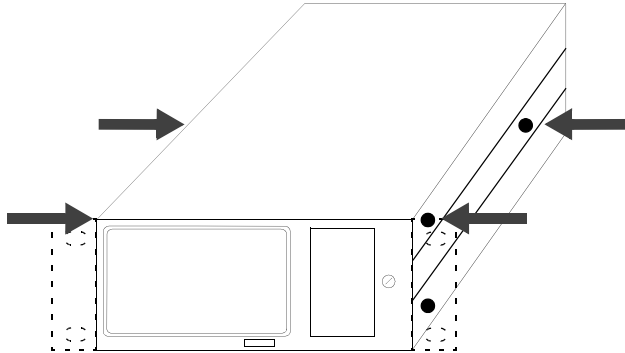







### CAUTION

**Failure to check system programming before switching to automatic operation can cause measurement error.**

To avoid measurement error due to inaccurate output signals, carefully check the system programming before switching to automatic operation.



### WARNING

**Failure to install appropriate pressure relief devices for high-pressure applications can cause product damage or personal injury.**

For automatic backfilling and other applications in which malfunction or normal process conditions can cause high pressures to occur, install appropriate pressure relief devices.

#### 4.1 Gauge Installation Tips

For best results locate pressure gauges close to the point where pressure needs to be measured. Gas sources, long tubing or other constrictions can cause large errors in indication. Note that if placed near the pump, the pressure in the gauge may be considerably lower than in the rest of the system. If placed near a gas inlet or source of contamination, the pressure in the gauge may be much higher. See Section 4.9 on page -53 for detailed gauge mounting instructions.

To minimize temperature effects, locate pressure gauges away from internal and external heat sources in a region where the ambient temperature is reasonably constant.

Parts of the gauge can get quite hot during degassing, especially if there is poor ventilation. This will not damage the gauge. However, care should be taken to prevent low temperature rated materials such as plastic wire insulation from touching hot parts of the gauge.

#### 4.2 FCC and EU Installation Requirements

To maintain compliance with FCC Part 15 rules and European Union's electromagnetic interference (EMI) directives, install shielded cable with a braided shield and metal or metallized plastic backshells that connect directly to the cable shield at the 15-pin I/O connector. Connect the shield to ground at your equipment. Failure to install the controller as described above can result in failure of the controller to the requirements for radiated emissions and susceptibility.

**4.3 Cable Installation**

It is intended that all wiring either to or from the controller, whether supplied by Brooks Automation, Inc. or not, be installed in accordance with the safety requirements of NEC/NFPA 70. Cables provided by Brooks Automation for connection to sensors or transducers is, at a minimum, designed for use as appliance wiring material (UL category AVL2), and is constructed of appropriate material and dimensions for the voltages and currents provided by the controller. It is emphasized that it is the user's responsibility to install cables to/from the controller whether provided by Brooks Automation, Inc., or not, in accordance with the applicable local, state and national safety requirements.

Raceway and/or conduit may be needed for certain installations.

**4.4 Environmental Conditions**

- Indoor Use.
- Altitude up to 2000 meters.
- Temperature 0 °C to 50 °C.
- Maximum relative humidity 80% for temperatures up to 31 °C decreasing linearly to 50% relative humidity at 50 °C.
- Transient overvoltages according to installation category (overvoltage category) II.
- Pollution degree 2 in accordance with IEC664.

**4.5 Controller Installation**

The controller is designed to operate a Series 355 Micro-Ion Gauge. This is an all-metal miniature gauge with dual yttria-coated iridium or dual tungsten filaments and a nominal sensitivity of 20/Torr.

The Micro-Ion Gauge electrometer module provides ion gauge pressure readout from  $1 \times 10^{-10}$  Torr ( $1.3 \times 10^{-10}$  mbar or  $1.3 \times 10^{-8}$  pascal) to  $5 \times 10^{-2}$  Torr, N<sub>2</sub> equivalent, depending on the emission current used.

Adjustment is provided for gauge sensitivity. See *Gauge Electrometer Operation* on page 98. Adjustment and an internal switch allow change to mbar or pascal pressure units, and a user selectable "slow update" feature triggers measurement averaging, resulting in a display update frequency of about once every three seconds. The overpressure shutdown threshold is internally adjustable.

1. Provide adequate ventilation for the Controller to dissipate 15 W.
2. Do not mount the Controller above other equipment that generates excessive heat.
3. This product is designed to operate over the range 0 to 50 °C. Ambient temperatures above 50 °C may damage the product. For optimum electrometer calibration stability, the Controller ambient temperature should be  $25 \pm 5$  °C.

**Table 4-1 Installation Hardware Part Numbers**

Adapter Hardware Description	Mounting Hardware Part Number	Series 358 Controller Catalog Number
To mount the Controller only on the left side of a 19 inch rack	370010	358502
To mount the Controller in the center of 19 in. rack	370011	358503
To mount two Controllers side-by-side in a 19 in. rack	370021	
To mount 1/2-rack (Standard)	N/A	358501

**4.6 Mounting Configurations**

Figure 4-1 illustrates the various configurations available for mounting the controller. The standard mounting configuration is 1/2-rack mount (358501). Other configurations are available using the mounting hardware kits listed in Table 4-1, and shown in Figure 4-1. Contact a Brooks Automation/Granville-Phillips Customer Service Representative for special mounting configurations. See page 4 of this instruction manual for more information and catalog numbers.

The controller should be mounted in a location with free air flow and ambient temperature less than 50 °C.

**Figure 4-1 Controller Mounting Configurations**

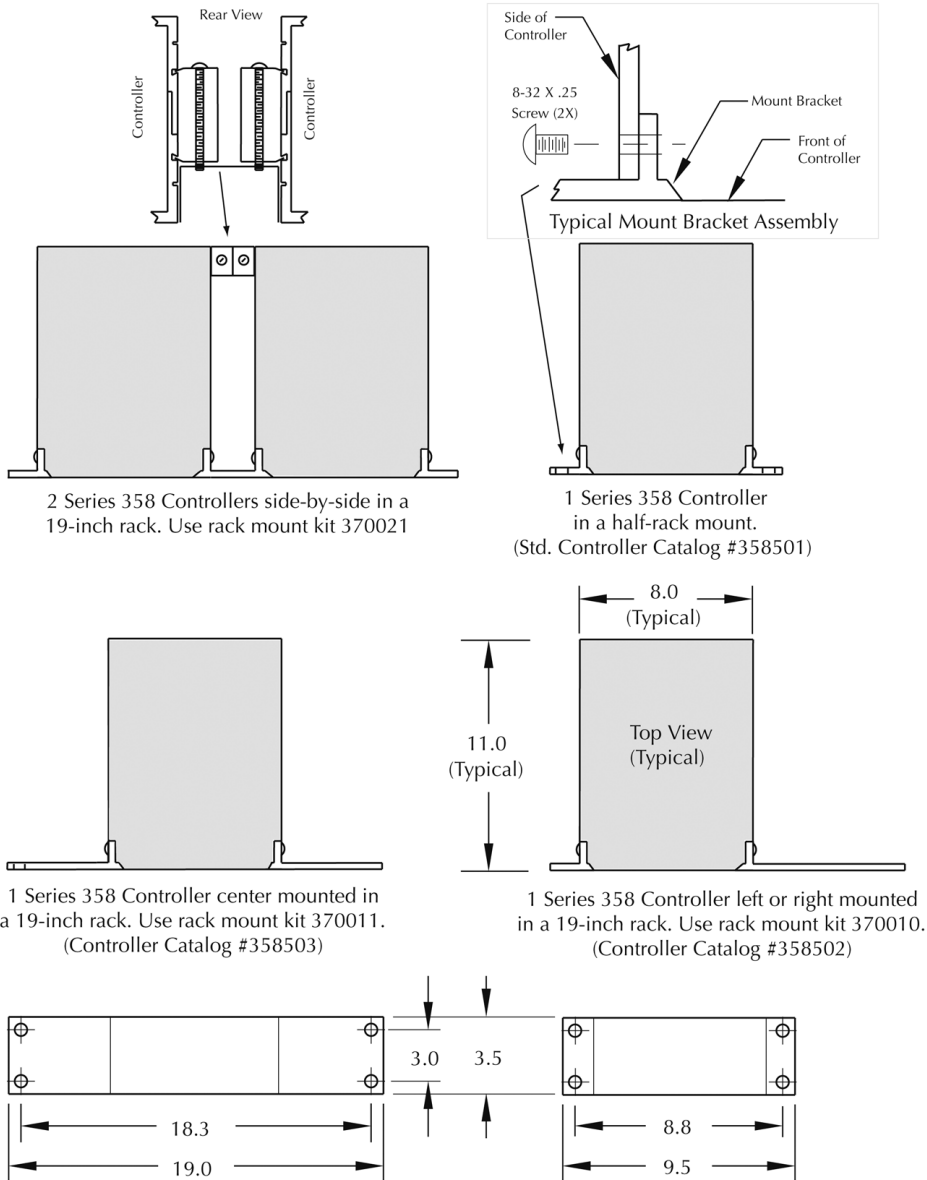

Series 358 Micro-Ion Gauge Controller Mounting Configurations. Dimensions are in Inches. Not to scale.

- 4.7 Line Voltage**
- The controller will operate over a line voltage range of 100 to 240 VAC, 50 to 60 Hz. All that is required is that a line cord be selected to match your available power receptacle to the power input connector located on the rear of the Controller.
- Fuse type: 5 x 20 mm time lag (T); low breaking capacity 1.6 A, 250 V; manufacturer, Schurter, Part No. FST034.3119
- Replacement fuses are available from Brooks Automation, Inc. Contact information is provided in the Service section, on page 3, and the back cover of this instruction manual.
- 4.8 Fuse Replacement**
1. On the rear panel, turn the power switch OFF and unplug the power cord.
  2. Use a flat tip screwdriver (or similar tool) to turn the fuseholder counterclockwise.
  3. Pull out the fuseholder, then remove and replace the fuse.
  4. Insert the fuseholder and turn clockwise to lock position.
  5. Plug in the power cord and turn the power switch ON.
- 4.9 Vacuum Gauge Installation**
- The following information pertains to the the proper installation of a Micro-Ion Gauge, a Convectron Gauge, and a capacitance manometer gauge. The gauges are illustrated in Figure 2-1 on page 13, and the cable connectors are illustrated in Figure 2-5 on page 17.
- The Series 358 Micro-Ion Vacuum Gauge Controller is capable of operating a Micro-Ion gauge located up to 50 feet away, and Convectron Gauge located up to 200 feet away by using standard cables provided by Brooks Automation, Inc./Granville-Phillips.
- After the gauges are installed on the chamber, be sure the system is properly grounded as outlined in Section 4.11 on page -55 and Figure 4-3 on page 58.
- Cleanliness pays. Keep the port cover in place until moments before installation.
  - Do not mount a vacuum gauge in a manner such that deposition of process vapors upon the internal surfaces can occur through line-of-sight access to its interior. If condensates may be present, orient the port downward to help liquids drain out.
  - For proper operation above about 1 Torr, install Convectron gauges with the gauge axis horizontal. To minimize pressure indication errors, avoid installing the Convectron gauge where it will vibrate. Vibration causes convection cooling of the sensor and will cause the pressure indication to be high.

- Physical dimensions of Micro-Ion and Convecatron Gauges are shown in Figure 2-9 on page 24 and Figure 2-10 on page 24.
- Mounting clearance dimensions for Convecatron Gauges are shown in Figure 4-2.

#### 4.10 Mounting Options

##### ***Compression Mount/Quick Connect***

Do not use for positive pressure applications. The gauge may be forcefully ejected.

The gauge port is designed to fit a standard 1/2 in. compression/quick connect mounting such as an Ultra-Torr<sup>®</sup> fitting.

Remove the caplug from the gauge tube port, insert the gauge tube port into the compression fitting and finger tighten the press ring. If a seal is not achieved it may be due to extreme cleanliness of the O-ring. A light film of vacuum grease such as Apiezon<sup>®</sup> grease will ensure sealing and is normally preferable to the use of pliers or pipe wrench to further tighten the press ring. You may point the electrical pins of the gauge tube anywhere you wish in a 360° horizontal circle for optimum routing of the gauge tube cable.

##### ***1/8 NPT Mount***

Fits standard 1/8 NPT female fitting. Wrap the threads of the gauge port with Teflon<sup>®</sup> tape and hand tighten. Do not use a wrench or tool. Tighten only sufficiently to achieve a seal.

##### ***VCR<sup>®</sup>/VCO Mount***

Remove the plastic or metal bead protector cap from the bead. When using gasket, place it into the female nut where applicable. Assemble components and snug finger-tight. While holding a backup wrench stationary, tighten the female nut 1/8 turn past finger-tight for 316 stainless steel and nickel gaskets; or 1/4 turn past finger-tight for copper and aluminum gaskets.

##### ***NW10KF, NW16KF, NW25KF and NW40KF Flange Mount***

The KF mounting system requires an O-ring and centering ring to be placed between the mating flanges. The flanges are then held together with the aluminum flange clamp by tightening the wing nut. Maximum pressure for this style mounting system is 1000 Torr absolute.

##### ***ConFlat Flange Mount***

To minimize possibility of leaks with ConFlat flanges, use high strength stainless steel bolts and a new, clean OFHC copper gasket. Avoid scratching the seal surfaces. To avoid contamination, do not use nonmetal gaskets.

After finger tightening all bolts, continue tightening about 1/8 turn in crisscross order, e.g., 1, 4, 2, 5, 3, 6, 4 . . . until flanges are in contact. After contact, further tighten each bolt about 1/16 turn.

Figure 4-2 Convectron Gauge Installation

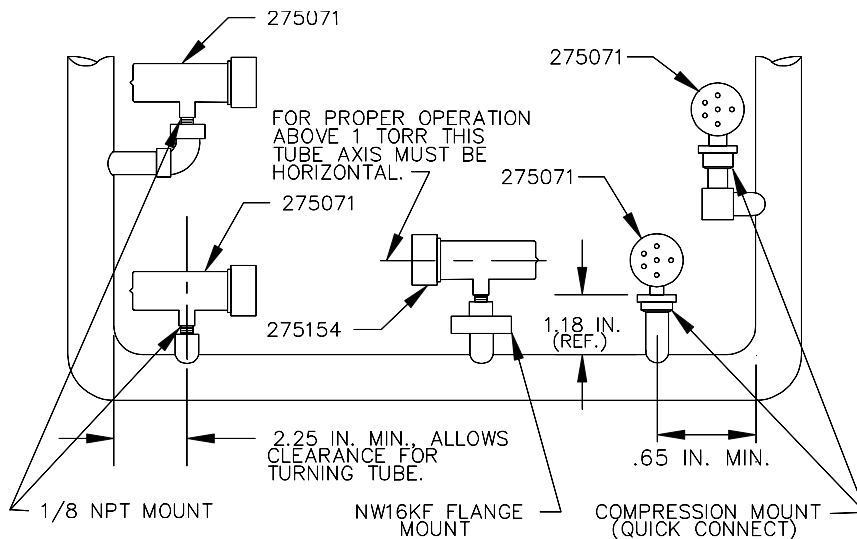

#### 4.11 Grounding the System

When high voltages are used within the vacuum system and the gauge envelope is not reliably grounded through its vacuum connection, either a separate ground wire must be added, or the envelope must be shielded to positively prevent human contact. The gauge envelope may be grounded by using a metal hose clamp on the gauge connected by a #12 awg copper wire to the grounded vacuum chamber. See Figure 4-3.



### WARNING

**Improper grounding can cause product damage or personal injury.**

Follow ground network requirements for the facility.

- Maintain all exposed conductors at earth ground.
- Connect the power cord to a properly grounded outlet.
- Make sure the vacuum port to which the gauge is mounted is properly grounded.
- Connect the gauge envelope to a facility ground. If necessary, use a ground lug on the flange bolt.

High voltage can couple through a gas to the internal electrodes of a gauge. Do not touch the exposed pins on any gauge installed on a vacuum system where high voltage is present.



## WARNING

**Touching the pins on the gauge in a high-voltage environment can cause an electrical discharge through a gas or plasma, resulting in property damage or personal injury due to electrical shock.**

Vent the vacuum chamber to atmospheric pressure and shut OFF power to the controller before you touch the pins on the gauge.

1. Connect a heavy duty ground wire #12 AWG or larger from the ground lug on the back of the Controller to your facility grounding electrode system (see item 3 on Figure 2-5 on page 17). This will provide an earth ground for the Controller in the event the interconnect cables are not in place. Do not connect the ground lug to the vacuum system or other component. Connect it directly to the facility grounding system such as a grounded outlet box or a grounded copper water supply pipe. Do not rely on small metal water lines to ground a component. Later on someone may replace the metal tubing with plastic tubing thus unwittingly causing a potentially dangerous situation.
2. Provide a connection to ground for other instruments with electrodes in the vacuum system possibly exposed to high voltage electrical discharges.
3. Provide a connection to ground for each ungrounded metal component in, on or around the vacuum system, including the gauge envelopes, which personnel may touch and which can potentially be exposed to high voltage electrical discharges within the vacuum system. For example, a metal bell jar resting on an organic O-ring must be connected to ground if a Micro-Ion gauge is to be used or if other high voltage sources are present in the vacuum system.



### System Ground Test Procedure

- Physically examine the grounding of both the controller and the vacuum chamber to assure that all exposed conductors of the system are properly grounded.
- Note that a horizontal “O” ring or “L” ring gasket, without metal clamps, can leave the chamber above it electrically isolated.
- Power can be delivered to mechanical and diffusion pumps without any ground connections to the system frame or chamber.
- Water line grounds can be lost by a plastic or rubber tube interconnection. What was once a carefully grounded vacuum system can, by innocent failure to reconnect all ground connections, become a very dangerous device.

### Procedure for Testing Grounding of Systems

Use the following procedure to test each of your vacuum systems that incorporate an Micro-Ion gauge.

This procedure uses a conventional volt-ohm meter (VOM) and a resistor (10  $\Omega$ , 10 W).

1. With the Controller turned OFF, test for both DC and AC voltages between the metal parts of the vacuum chamber and the power supply chassis.
2. If no voltages exist, measure resistance. The resistance should not exceed 2  $\Omega$ . Two ohms or less implies commonality of these grounds that should prevent the plasma from creating a dangerous voltage between them. This test does not prove that either connection is earth ground, only that they are the same. If more than 2  $\Omega$  is indicated, check with your electrician.
3. If AC or DC voltages exist and are less than 10 V, shunt the meter with a 10  $\Omega$ , 10 W resistor. Repeat the voltage measurement. With the shunt in place across the meter, if the voltage remains at 83% or more of the unshunted value, commonality of the grounds is implied. Repeat the measurements several times to be sure that the voltage ratio is not changing with time. If the condition in the following equation exists, this should prevent the plasma from creating a dangerous voltage between these grounds. If more than 10 V exists between grounds, check with your electrician.

$$\frac{\text{Voltage (shunted)}}{\text{Voltage (unshunted)}} = 0.83 \text{ or more}$$

4. If the voltage calculation in Step 3 is less than 0.83, due to the placement of the shunt, it complicates the measurement. The commonality of the grounds may be satisfactory and the coupling poor, or the commonality could be poor! Your electrician should be asked to check the electrical continuity between these two ground systems.

*NOTE: The placement of a second ground wire, (dashed line in Figure 4-3), between the vacuum chamber and the controller chassis is not a safe grounding procedure. Large currents could flow through it.*

**Figure 4-3 System Grounding**

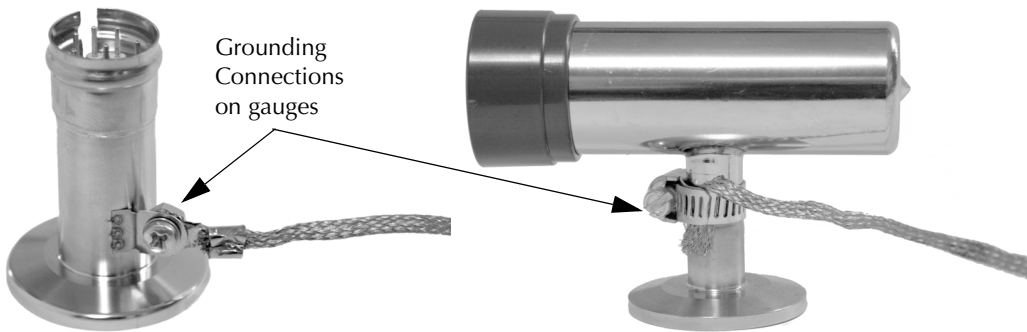
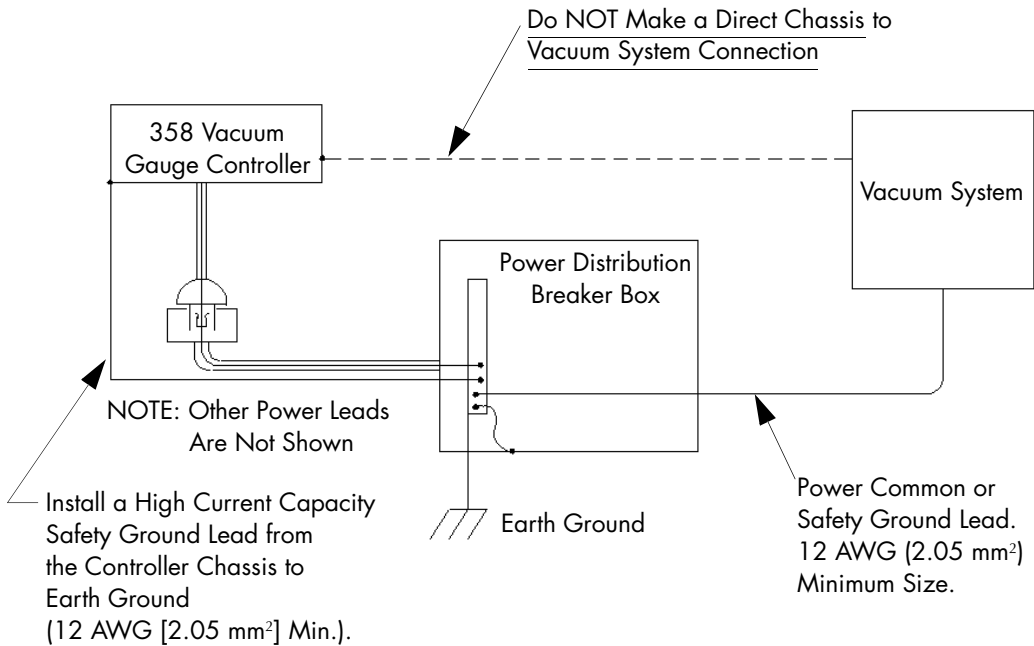

#### 4.12 Connecting Analog Outputs

##### Electrometer Module Analog Output Signal

This voltage is proportional to the logarithm of the pressure, scaled to 1 V per decade with 0 V at  $1 \times 10^{-11}$  Torr. When the Micro-Ion gauge is turned OFF, the output will switch to slightly over +10 V. See Figure 5-5 on page 70.

A standard 1/8" miniature phono jack connector is supplied.

Figure 4-4 Convectron Gauge Analog Output Connector

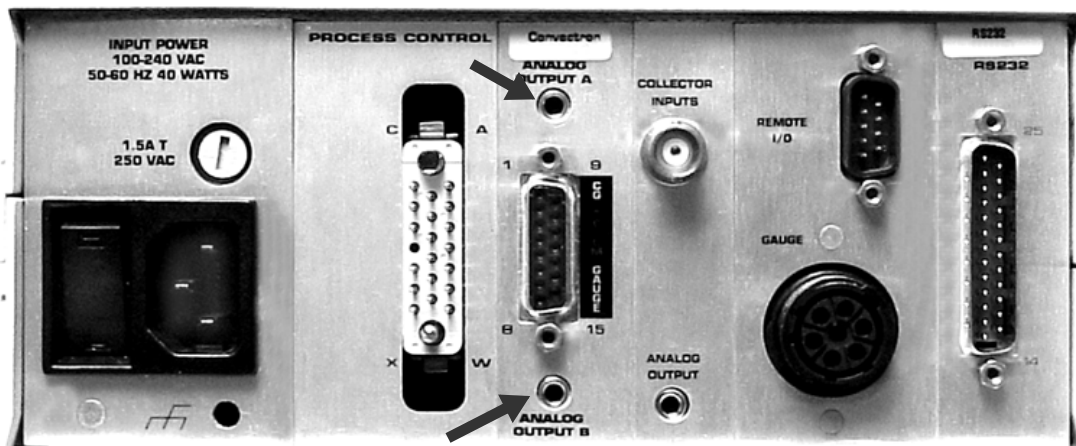

##### Convectron Gauge Analog Output Signal

If you have Convectron gauge capability installed, signal voltages proportional to the logarithm of the Convectron gauge display indications are provided on the back of the Convectron gauge module via a standard 1/8" miniature phono jack. See Figure 4-4. Two mating connectors are supplied with this capability. See *Convectron Gauge Analog Output Signal* on page 82 pertaining to the characteristics of these signals.

An analog output jack is provided on the rear panel. This is a DC voltage proportional to the logarithm of the pressure, scaled to 1 V per decade:  
 $0 \text{ V} = 1 \times 10^{-4}$  or less, Torr or mbar,  $1 \text{ V} = 1 \times 10^{-3}$ , etc.

For pascal units, the analog output will be scaled to  $0 \text{ V} = 1 \times 10^{-2}$  pascal.

Internal offset adjustments are provided that allow a shift in the analog output at  $1 \times 10^{-4}$  Torr away from 0 V to anywhere in the range -7 to +1 V. This adjustment does not affect the slope of the analog output vs pressure curve.

**4.13 Connecting a Capacitance Manometer**

If you have a Capacitance Manometer capability installed, signal voltages are provided on the back of the Convectron Gauge module via a standard 1/8 in. miniature phone jack - the Analog Output B port shown in Figure 4-4. Two mating connectors are supplied with this capability.

The wires provided for the capacitance manometer are terminated as bare wires. Refer to the documentation provided with the capacitance manometer for connection instructions. Be sure to protect all unused leads from shorting.

**Figure 4-5 Capacitance Manometer PCB**

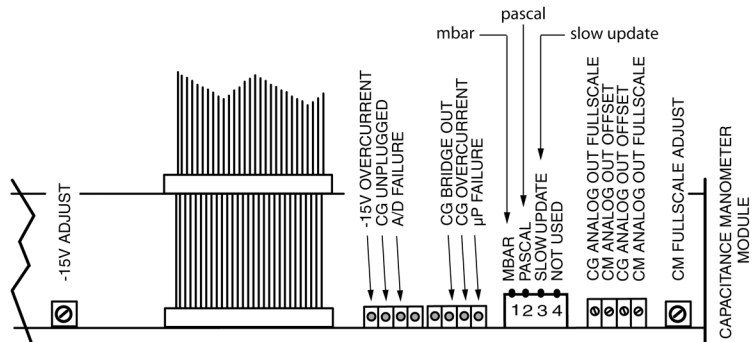

**Figure 4-6 Capacitance Manometer Wiring Diagram**

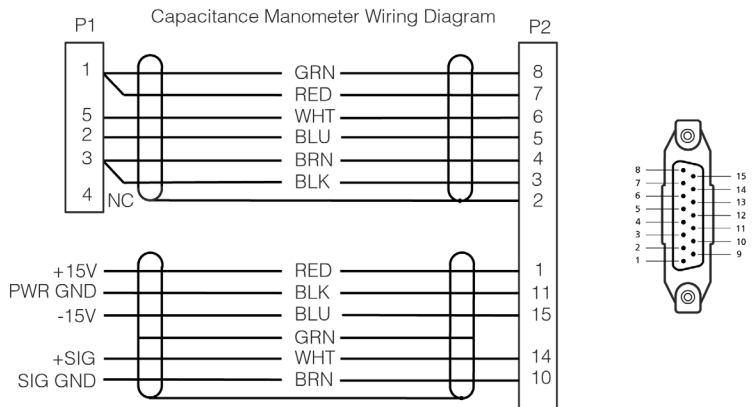

### Capacitance Manometer Analog Output Signal

The analog output for the capacitance manometer is a dc voltage proportional to the pressure with a range of 0 to 10 volts, proportional to the transducer output. Refer to the documentation provided with your transducer for a description of this output.

Internal adjustments are provided for zero offset and full-scale (gain) control.

### Capacitance Manometer Analog Output Offset Adjustment

Adjust the *CM Analog Output Offset* potentiometer (Figure 4-5) to set the analog output "B" at Base pressure. The output can be adjusted between -0.2 and +0.2 volts at Base pressure for the capacitance manometer.

Figure 4-7 Analog Output Connectors A and B

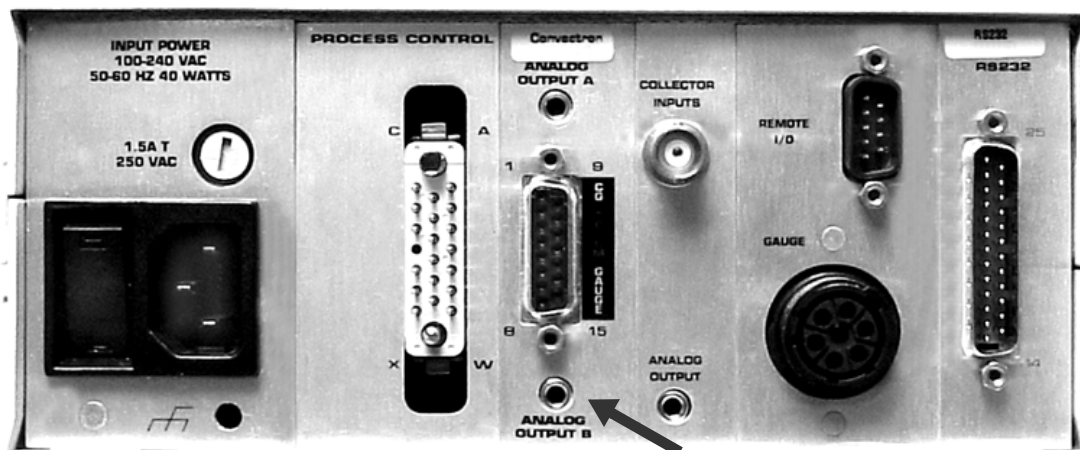

### Capacitance Manometer Analog Output Full-scale Adjustment

There are 4 switch selections for the maximum output range of the capacitance manometer gauge. Use the selection switch on the front panel of the 358 Controller (See Figure 5-15 on page 84) to select the maximum pressure to match the capacitance manometer transducer on your system. See Table 4-2.

The analog output full scale adjustment is a span or gain control, with a range of 0.93 to 1.3. The factory setting is for a gain of 1.0, thus 10 volts in from the transducer (maximum readable pressure) = 10 volts out at the factory setting.

**Table 4-2 Capacitance Manometer Analog Output Voltage/Pressure**

Volts	Pressure Torr	Pressure Torr	Pressure Torr	Pressure Torr
	1000 Torr Head	100 Torr Head	10 Torr head	1Torr Head
10	1000	100	10	1
1	100	10	1	.1
.1	10	1	.1	.01
.01	1	.1	.01	.001

Pressure = Volts multiplied by Scaling #

$P = V \times 100$  (1000 Torr Head)

$P = V \times 10$  (100 Torr Head)

$P = V \times 1$  (10 Torr Head)

$P = V \times .1$  (1 Torr Head)

#### **Capacitance Manometer Full-scale Adjustment**

The full-scale adjustment potentiometer (Figure 4-5) controls the full-scale readout of the capacitance manometer display. The control is adjusted at the factory for a full-scale display with an input of 10.0 volts. After zeroing the Controller as described above, the Controller can be calibrated to the transducer by adjusting the full-scale adjust potentiometer so the Controller display corresponds to the pressure of the manometer at or near the maximum pressure.

This reference pressure may be determined by a certified standard gauge, a dead weight calibration system, or a standard voltage reference. The full-scale adjust potentiometer and the CM analog out full-scale potentiometer do not interact and can be adjusted independently.

**4.14 Connecting Process Control Relays**

For instructions for setting up this module, see *Process Control Setup* on page 32.

The process control connector is embossed with letters identifying corner pins. Table 4-3 shows the letters designating the 3 pins assigned to each of the 6 setpoint channels.

**Figure 4-8 Process Control Output Connector**

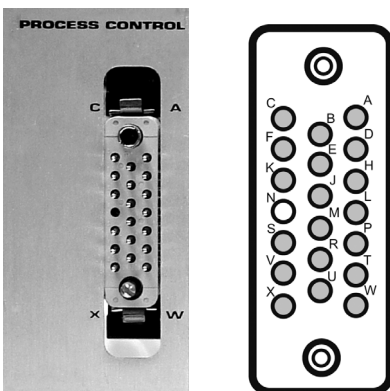

**Table 4-3 Process Control Output Connector Pin Assignments**

Process Control Channel	Micro-Ion Gauge		Convectron Gauge A		Convectron Gauge B	
	1	2	3	4	5	6
Common (or Pole)	W	H	M	C	J	S
Normally Closed (NC)	P	A	U	K	B	X
Normally Open (NO)	T	D	R	F	E	V
CHASSIS GND – PIN L			NO CONNECTION – PIN N			

A mating connector is supplied in the hardware kit.

**⚠ CAUTION**

**Failure to check system programming before switching to automatic operation can cause measurement error.**

To avoid measurement error due to inaccurate output signals, carefully check the system programming before switching to automatic operation.

Initial Setup

**! WARNING**

**Failure to install appropriate pressure relief devices for high-pressure applications can cause product damage or personal injury.**

For automatic backfilling and other applications in which malfunction or normal process conditions can cause high pressures to occur, install appropriate pressure relief devices.

1. Using Figure 4-8 and Table 4-3, and circuit schematics you have prepared, make up a cable to connect the various system components which are to be controlled. Unambiguous labeling of each lead will help prevent costly mistakes.
2. Ensure that the Process Control channel override switches are all set to OFF.
3. Connect the component end of the cable to the system component to be controlled.
4. Plug the connector into the back of the Controller.
5. Refer to *Preparing for Process Control Operation* on page 85 for instructions for setting setpoints.

**Figure 4-9 Override Switches**

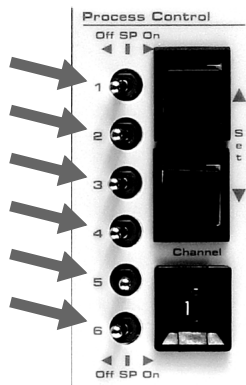



#### 4.15 Connecting the RS-232 Computer Interface Handshake Lines

For instructions for setting up this interface, see *RS-232 Computer Interface Setup* on page 37.

The DTR line is set true on power up to indicate it is on line. When the controller receives a start bit on the received data line it will input and buffer a character. The DCD line must be true at the time each character is received or that character will be ignored. The controller will continue to receive and buffer characters until the terminator (LF) is received.

Upon receiving the terminator, the controller will assert the RTS line as a holdoff, to prevent the host computer from attempting to transmit further data until the message just received has been decoded and a reply has been output.

During output of the reply, the incoming handshake lines CTS, and DSR are tested prior to beginning transmission of each character. The controller will wait until both are true before beginning transmission of a character, and will not test them again until ready to begin transmitting the next character.

After transmitting the terminator, the controller will negate RTS and wait for the next incoming message.

**Figure 4-10 Controller Rear Panel with RS-232 Option**

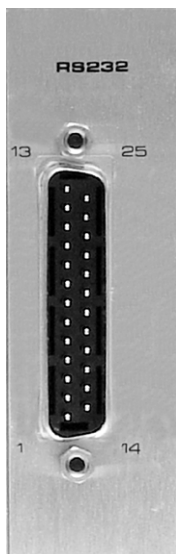

**RS-232 Handshake Line Summary**

CTS, DSR

Set the computer to indicate that controller may output the next byte in its message. As shipped from the factory these lines are forced "TRUE" by the switch settings of the controller RS-232 printed circuit board. Thus the controller will automatically assume the host is ready to receive. See Figure 3-12 on page 39 for the location of these switches.

DCD

Tested by controller when a character is received. The character will be ignored unless DCD is "TRUE". As shipped from the factory, this line is forced "TRUE" by the switch settings.

DTR

Always asserted by the controller. A "power ON" indication.

RTS

Negated by the controller on power-up. Asserted by the controller upon receipt of a message terminator. Negated after transmitting the terminator of the controller's response to that message.

**Reversing RTS Polarity**

If switch 2 is open on power-up, the controller will apply the opposite polarity to RTS from that described above. When used in this mode, RTS may be connected to the CTS input of the host computer. This violates the RS-232 standard, but is a commonly used implementation.

**4.16 Connecting RS-485 Computer Interface**

For instructions for setting up this interface, see *RS-485 Computer Interface Setup* on page 42.

Connectors J1 and J2 on the rear panel of the controller (Figure 3-16) are wired in parallel and are interchangeable. Connection can easily be made by "daisy chaining" gauge Controllers together with the signal from the host computer going into one connector then out the other to another gauge Controller and so on.

The maximum total cable length is 4000 ft. The maximum number of devices connected is 32.

The control of data over the RS-485 interface is handled by a Half-duplex Command/Response mechanism.

## Chapter 5 Preparing for Operation

### 5.1 Preparing for Pressure Measurement

Before preparing to operate the controller, make sure that:

- the controller has been properly set up and installed per the instructions in *Chapter 3* and *Chapter 4*,
  - the gas in your vacuum system is air or  $N_2$ . For other gases you must follow the instructions in *Preparing for Convectron Gauge Operation* on page 71 for using Convectron gauges, and
  - you are reasonably familiar with the general theory of operation of hot cathode Micro-Ion gauges and thermal conductivity gauges.
1. Turn ON the controller by pressing the power switch labeled ON. See Figure 5-1.

Figure 5-1 Power ON/OFF Switch

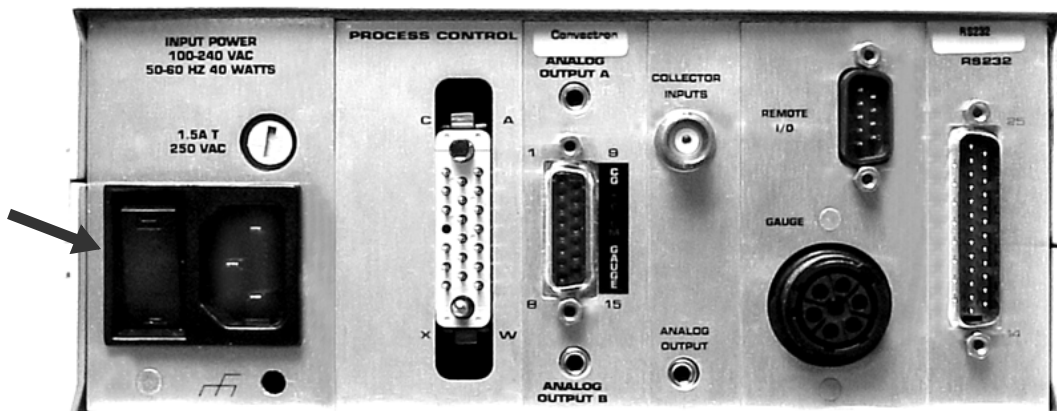

2. Convectron gauge equivalent  $N_2$  pressures will be displayed whenever power is applied if the gauges and cables are installed. See *Preparing for Convectron Gauge Operation* on page 71 for information on Convectron gauge pressure measurement.
3. The  $N_2$  equivalent pressure within the Micro-Ion Gauge will be displayed in the pressure units you have specified (Torr, mbar or pascal). See *Pressure Units Setup* on page 28 to change pressure units.

**5.2 Alternate ON/OFF Gauge Control**

The Micro-Ion Gauge can be turned ON and OFF in the following ways:

- Use the front panel Micro-Ion Gauge “momentary” GAUGE ON/OFF switch. See Figure 5-2.
- Automatically via the Auto ON function of the Convectron gauge module. See *Filament Auto ON* on page 80.
- Use the RS-232 or RS-485 Computer Interface modules. See *Command Syntax for RS-232 Computer Interface* on page 88 or *Command Syntax for RS-485 Computer Interface* on page 91.
- The ON/OFF toggle from the Remote Input/Output Connector. See *Micro-Ion Gauge Remote Input/Output* on page 68.

In addition, the Micro-Ion Gauge will be automatically turned OFF by excessive pressure.

**Figure 5-2 Micro-Ion Gauge Momentary ON/OFF Switch**

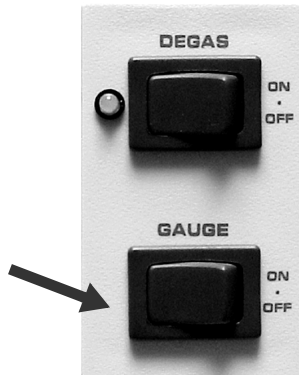

**5.3 Micro-Ion Gauge Remote Input/Output**

Two TTL compatible inputs are provided through the rear panel allowing control of the Micro-Ion gauge and degas. The function of the front panel keys is reproduced by either a contact closure or an asserted low (0V) logic state on these inputs. This low state must be held continuously at  $<0.4V@10\mu A$  (LOW) for at least 25 milliseconds. After this, the input must be allowed to pull high to  $>3.5V$ (HIGH) for at least 105 milliseconds before another low will be accepted. These inputs have passive pull-ups to +5 V internal supply.

A single-pole, double-throw relay is provided to indicate Micro-Ion gauge status (normally open contact is open when the Micro-Ion gauge is OFF).

**Figure 5-3 Input/Output Wiring Connector**

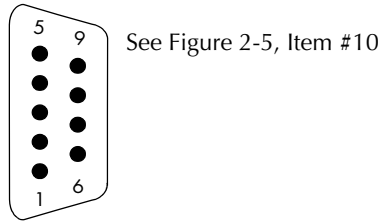

**Table 5-1 Remote Input/Output Pin Functions**

Pin Number	Function	Pin Number	Function
1	Gauge On/Off Remote*	6	Degas On/Off Remote*
2	Ground	7	Ground
3	Not Used	8	Not Used
4	Gauge Status Common	9	Gauge Status N.O. (Normally Open)
5	Gauge Status N.C. (Normally Closed)		
*Active low inputs			

**5.4 Micro-Ion Analog Output Signal**

A signal voltage proportional to the logarithm of the Micro-Ion pressure indication is provided on the back of the electrometer module via a standard 1/8 in. miniature phono jack.

**Figure 5-4 Electrometer Analog Output Jack**

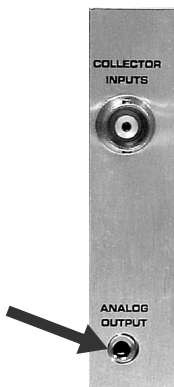

*Normal Measurement Operation*

Pressure indication:

$$P_i = 10^{V-11} \text{ Torr or mbar}$$

$$P_i = 10^{V-9} \text{ pascal}$$

*When Degassing*

Pressure indication:

$$P_i = 10^{V-13.92} \text{ Torr or mbar}$$

$$P_i = 10^{V-11.92} \text{ pascal}$$

*When the gauge is OFF*

V = 11 volts

This signal voltage is determined by the pressure indicated on the Micro-Ion Gauge display.

**Figure 5-5 Micro-Ion Gauge Analog Output Versus Pressure**

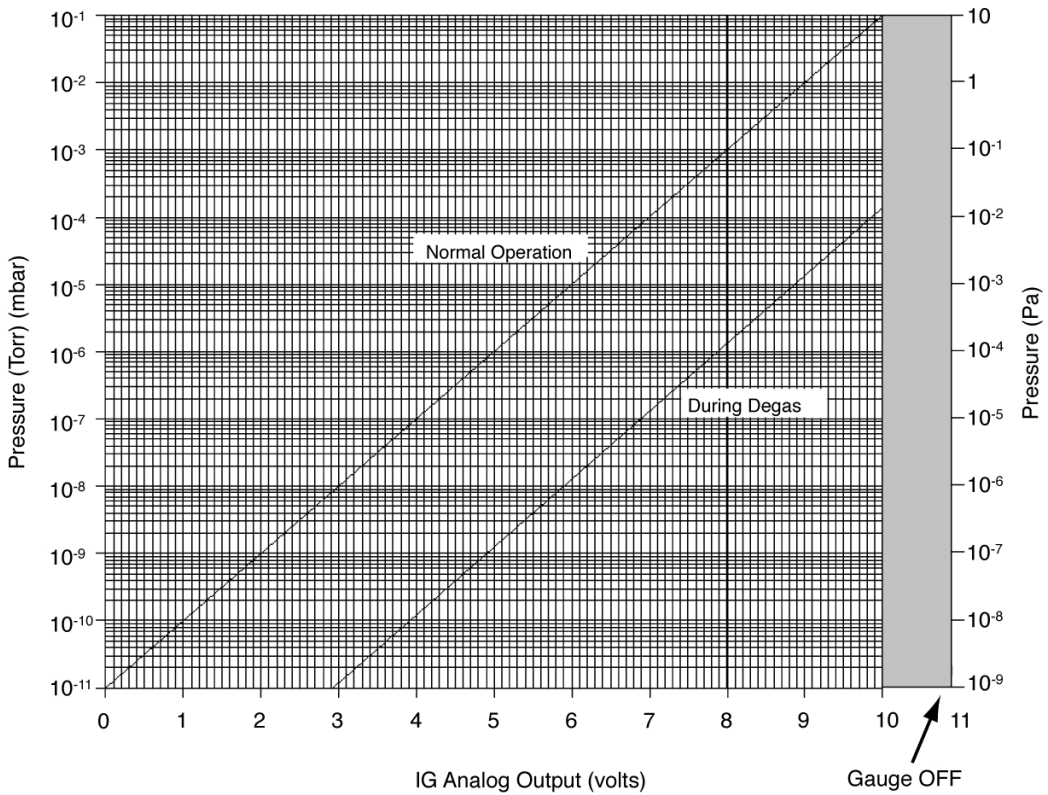

## 5.5 Preparing for Convector Gauge Operation

Convector Gauge pressures are indicated on lines A and B of the Controller display.



### WARNING

**Failure to use accurate pressure conversion data for N<sub>2</sub> or air to other gases can cause an explosion due to overpressurization.**

If the controller will measure any gas other than N<sub>2</sub> or air, before connecting the controller to system control devices, adjust pressure outputs for the process gas that will be used.

Install suitable devices that will limit the pressure to the level that the vacuum system can safely withstand. In addition, install suitable pressure relief valves or rupture disks that will release pressure at a level considerably below that pressure which the system can safely withstand.

Suppliers of pressure relief valves and pressure relief disks are listed in the Thomas Register under "Valves, Relief", and "Discs, Rupture."

Confirm that these safety devices are properly installed before installing the product. In addition, check that (1) the proper gas cylinders are installed, (2) gas cylinder valve positions are correct on manual systems, and (3) the automation is correct on automated systems.

Vacuum gauges with compression fittings may be forcefully ejected if the vacuum system is pressurized.

## 5.6 Gases other than Nitrogen or Air

Convector Gauges are thermal conductivity gauges of the Pirani type. These gauges transduce gas pressure by measuring the heat loss from a heated sensor wire maintained at constant temperature. For different gases, the heat loss is different at any given true pressure and thus the pressure indication can be very different.

It is important to understand that the indicated pressure of a Convector gauge depends on the type of gas, the orientation of the gauge axis, and on the gas density in the gauge. Convector gauges are normally supplied calibrated for N<sub>2</sub> (air has approximately the same calibration). With proper precautions, the Convector gauge may be used to measure pressure of certain other gases.

*The following information in this section applies only when the Convector Gauge has been calibrated for N<sub>2</sub> and when the Convector Gauge is mounted with its axis horizontal.*

At pressures below a few Torr, there is no danger in measuring pressure of gases other than N<sub>2</sub> and air, merely inaccurate indications. A danger arises if the N<sub>2</sub> calibration is used without correction to measure higher pressures of some other gases. For example, N<sub>2</sub> or air at 24 Torr causes the same heat

loss from the Convector sensor as will argon at atmospheric pressure. Thus if the pressure indication of the Convector gauge is not properly corrected for argon, an operator attempting to fill a vacuum system with 1/2 atmosphere of argon would observe an indication of only 12 Torr when the actual pressure had risen to the desired 380 Torr. Continuing to fill the system with argon to 760 Torr would result in only a 24 Torr indication. Depending on the pressure of the argon gas source, the chamber could be dangerously pressurized while the display continued to read about 30 Torr of N<sub>2</sub> equivalent pressure.

*The same type of danger likely exists with other thermal conductivity gauges using convection to extend the range to high pressures; and with Convector gauges calibrated for gas type Y when used with gas type X.*

Understand that, with a Convector Gauge calibrated for N<sub>2</sub>, to measure the pressure of gases other than N<sub>2</sub> and air you must use the conversion curves specifically for the Convector Gauge to translate between indicated pressure and true pressure. Do not use other data. Never use conversion curves for the Convector Gauge with gauges of other manufacturers. Their geometry is very likely different and dangerously high pressures may be produced even at relatively low pressure indications. Also, you must ensure that the atmosphere adjustments for Convector Gauges A and B are correctly set. See *Gauge Zero and Atmospheric Pressure Adjustment* on page 81.

Figure 5-6 through Figure 5-11 show the true pressure verses indicated pressure for eleven commonly used gases. The following list will help to locate the proper graph:

**Table 5-2 True Pressure vs. Indicated N<sub>2</sub> Pressure**

Figure and Page	Pressure Range and Units	Gases
Figure 5-6 on page 74	10 <sup>-4</sup> to 10 <sup>-1</sup> Torr	All
Figure 5-7 on page 75	10 <sup>-1</sup> to 1000 Torr	Ar, CO <sub>2</sub> , CH <sub>4</sub> , Freon 12, He
Figure 5-8 on page 76	10 <sup>-1</sup> to 1000 Torr	D <sub>2</sub> , Freon 22, Kr, Ne, O <sub>2</sub>
Figure 5-9 on page 77	10 <sup>-4</sup> to 10 <sup>-1</sup> mbar	All
Figure 5-10 on page 78	10 <sup>-1</sup> to 1000 mbar	Ar, CO <sub>2</sub> , CH <sub>4</sub> , Freon 12, He
Figure 5-11 on page 79	10 <sup>-1</sup> to 1000 mbar	D <sub>2</sub> , Freon 22, Kr, He, O <sub>2</sub>

Note that 1 mbar = 100 pascal, so the mbar charts may be used for pascal units by multiplying the values on the axes by 100.

A useful interpretation of these curves is, for example, that at a true pressure of 2 x 10<sup>-2</sup> Torr of CH<sub>4</sub> the heat loss from the sensor is the same as at a true pressure of 3 x 10<sup>-2</sup> of N<sub>2</sub>. See Figure 5-6 on page 74. The curves at higher



pressure vary widely from gas to gas because the thermal losses at higher pressures are greatly different for different gases.

If you must measure the pressure of gases other than N<sub>2</sub> or air, use Figure 5-6 through Figure 5-11 to determine the maximum safe indicated pressure for the other gas as explained below.

## Examples

### ***Maximum safe indicated pressure***

Assume a certain system will withstand an internal pressure of 2000 Torr or 38.7 psia. For safety, you want to limit the maximum internal pressure to 760 Torr during backfilling. Assume you want to measure the pressure of Freon 22. In Figure 5-8 on page 76, locate 760 Torr on the left hand scale, travel to the right to the intersection with the Freon 22 curve, and then down to an indicated pressure of 11 Torr (N<sub>2</sub> equivalent). Thus, in this hypothetical situation, the maximum safe indicated pressure for Freon 22 is 11 Torr.

For the sake of safety, it is prudent to place a warning label on the instrument face which under the assumed conditions would read "DO NOT EXCEED 11 TORR FOR FREON 22".

If the Convectron gauge calibration is for a gas type other than N<sub>2</sub> (or air), we suggest placing a label near the second and third lines of the display indicating the gas type or types used for calibration to prevent mix-ups.

### ***Indicated to true pressure conversion***

Assume you want to determine the true pressure of helium in a system when the Convectron Gauge is indicating 10 Torr. In Figure 5-7 on page 75, read up from 10 Torr (N<sub>2</sub> equivalent) indicated pressure to the Helium curve and then horizontally to the left to a true pressure of 4.5 Torr. Thus 4.5 Torr Helium pressure produces an indication of 10 Torr (N<sub>2</sub> equivalent).

### ***True to indicated pressure conversion***

Assume you want to set a process control setpoint at a true pressure of 20 Torr of CO<sub>2</sub>. In Figure 5-7 on page 75, locate 20 Torr on the true pressure scale, travel horizontally to the right to the CO<sub>2</sub> curve and then down to an indicated pressure of 6.4 Torr (N<sub>2</sub> equivalent). Thus the correct process control setting for 20 Torr of CO<sub>2</sub> is 6.4 Torr (N<sub>2</sub> equivalent).

### ***True to indicated pressure conversion***

Assume you want to obtain a helium pressure of 100 Torr in the system. In Figure 5-7 on page 75, locate 100 Torr on the left hand scale, travel horizontally to the right to attempt to intersect the He curve. Because the intersection is off scale, it is apparent that this true pressure measurement requirement for helium exceeds the capability of the instrument.

For gases other than those listed, the user must provide accurate conversion data for safe operation. The Convectron gauge is not intended for use above approximately 1000 Torr true pressure.

Figure 5-6 True Pressure versus Indicated Pressure for Commonly used Gases,  $10^{-4}$  to  $10^{-1}$  Torr

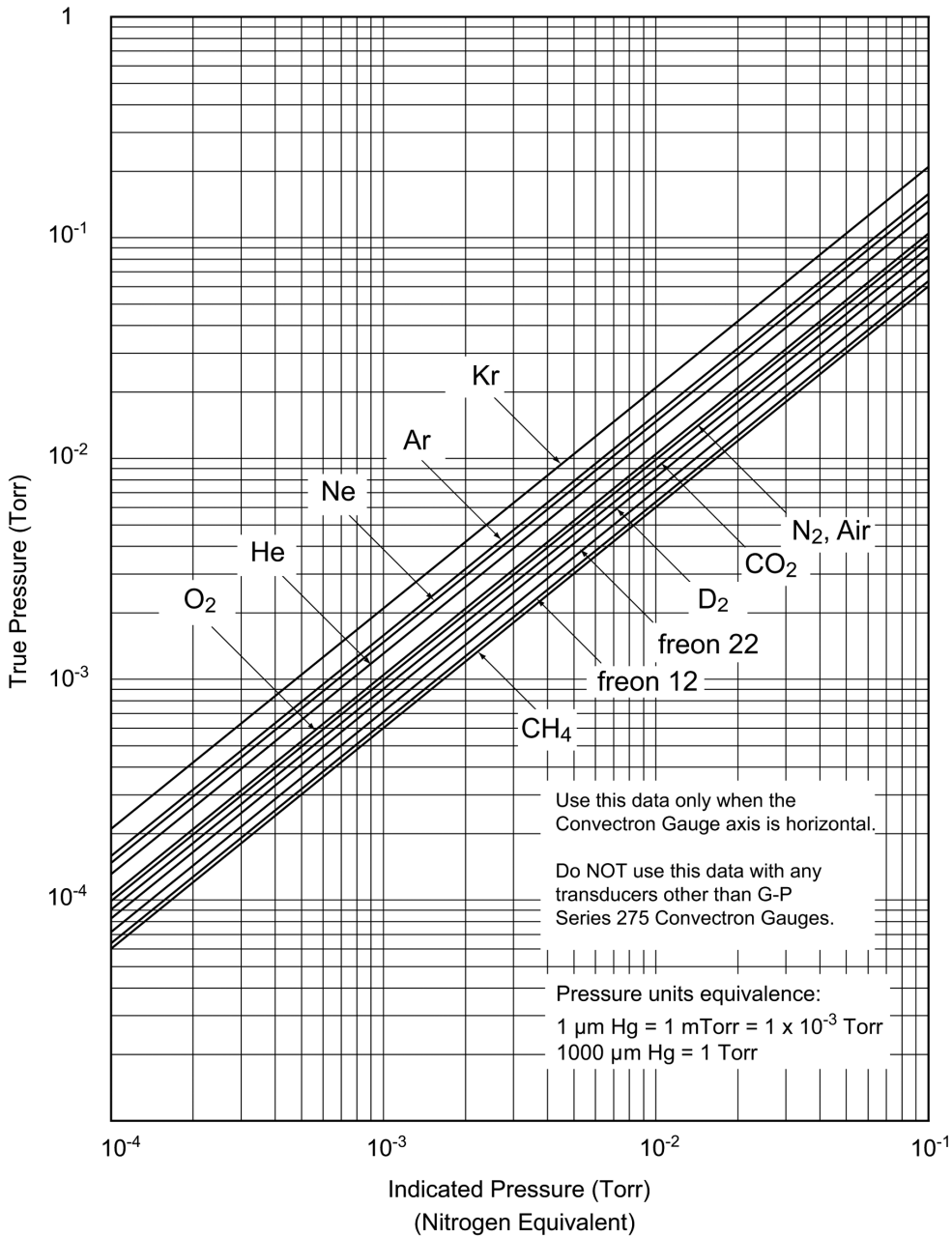

Figure 5-7 True Pressure versus Indicated Pressure for Commonly used Gases, 10<sup>-1</sup> to 1000 Torr

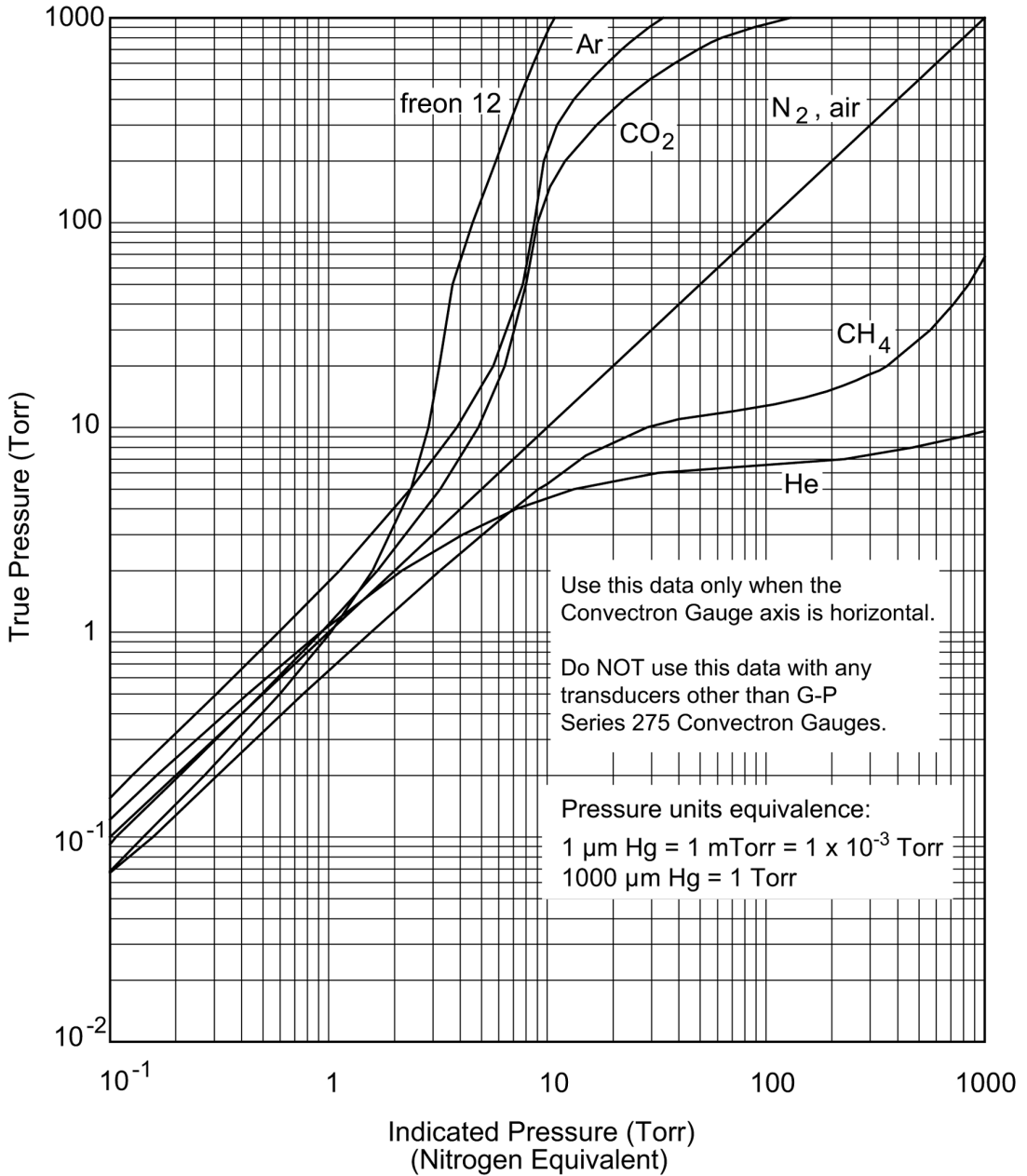

Figure 5-8 True Pressure versus Indicated Pressure for Commonly used Gases,  $10^{-1}$  to 1000 Torr

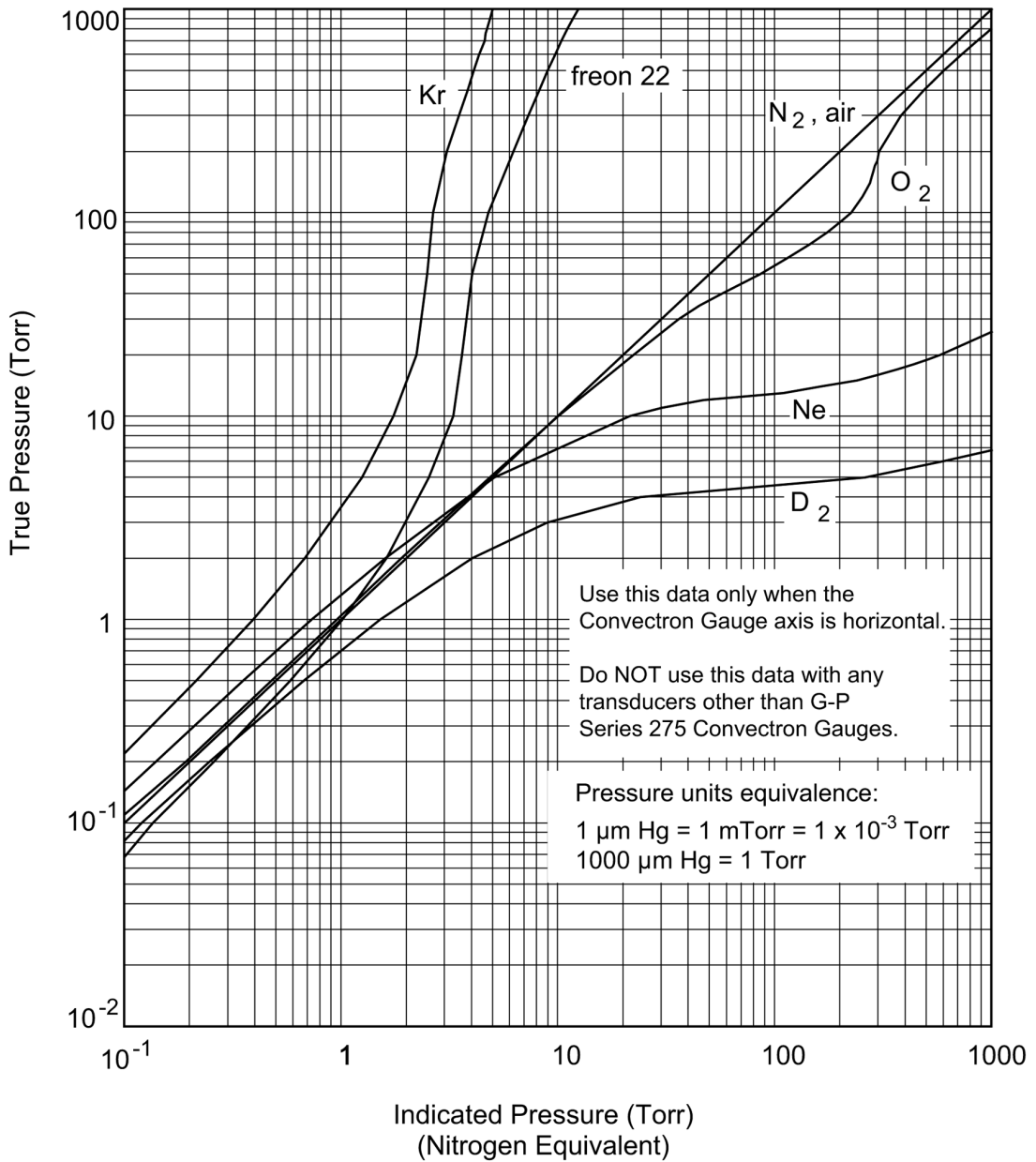

Figure 5-9 True Pressure versus Indicated Pressure for Commonly used Gases,  $10^{-4}$  to  $10^{-1}$  mbar

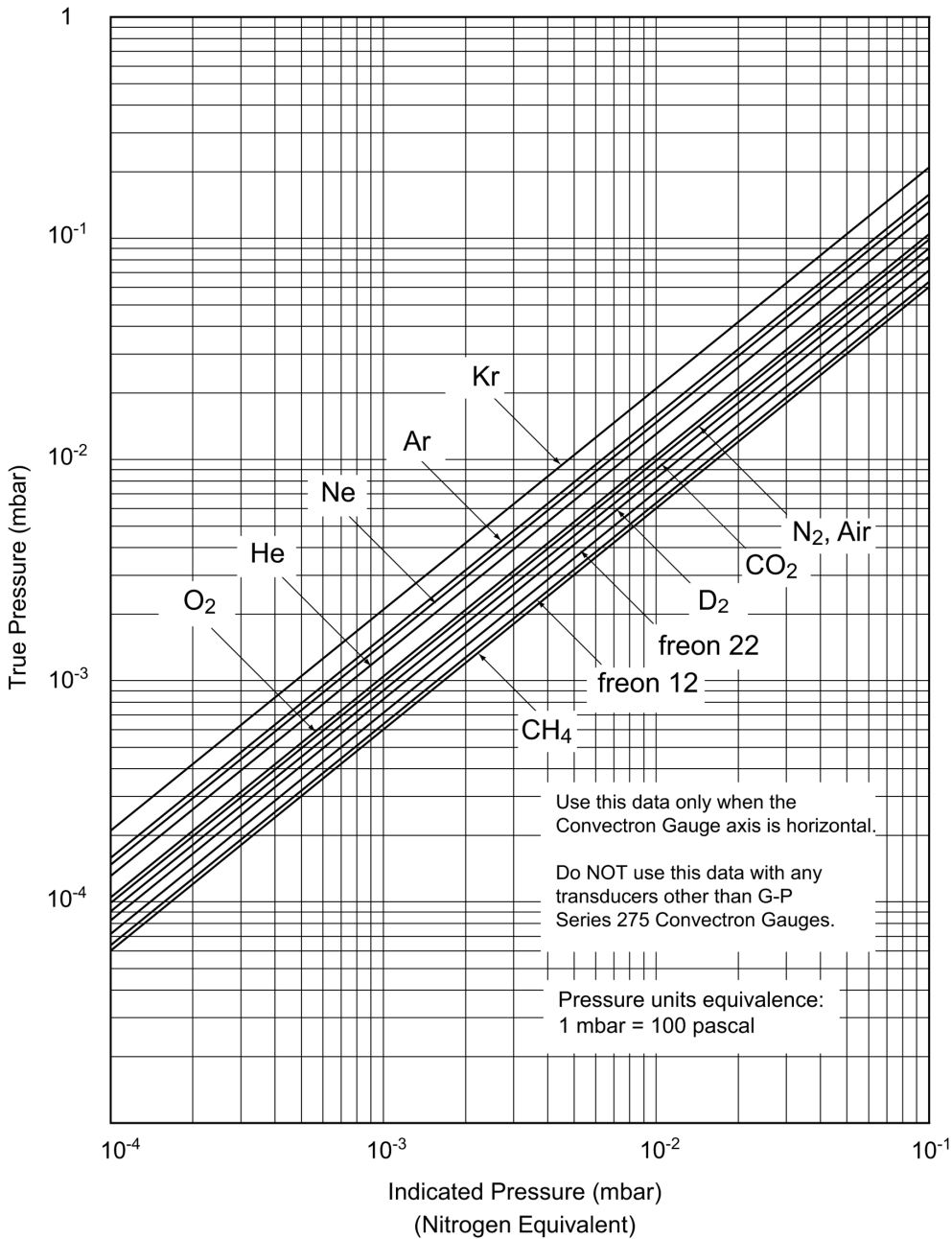

Figure 5-10 True Pressure versus Indicated Pressure for Commonly used Gases, 10<sup>-1</sup> to 1000 mbar

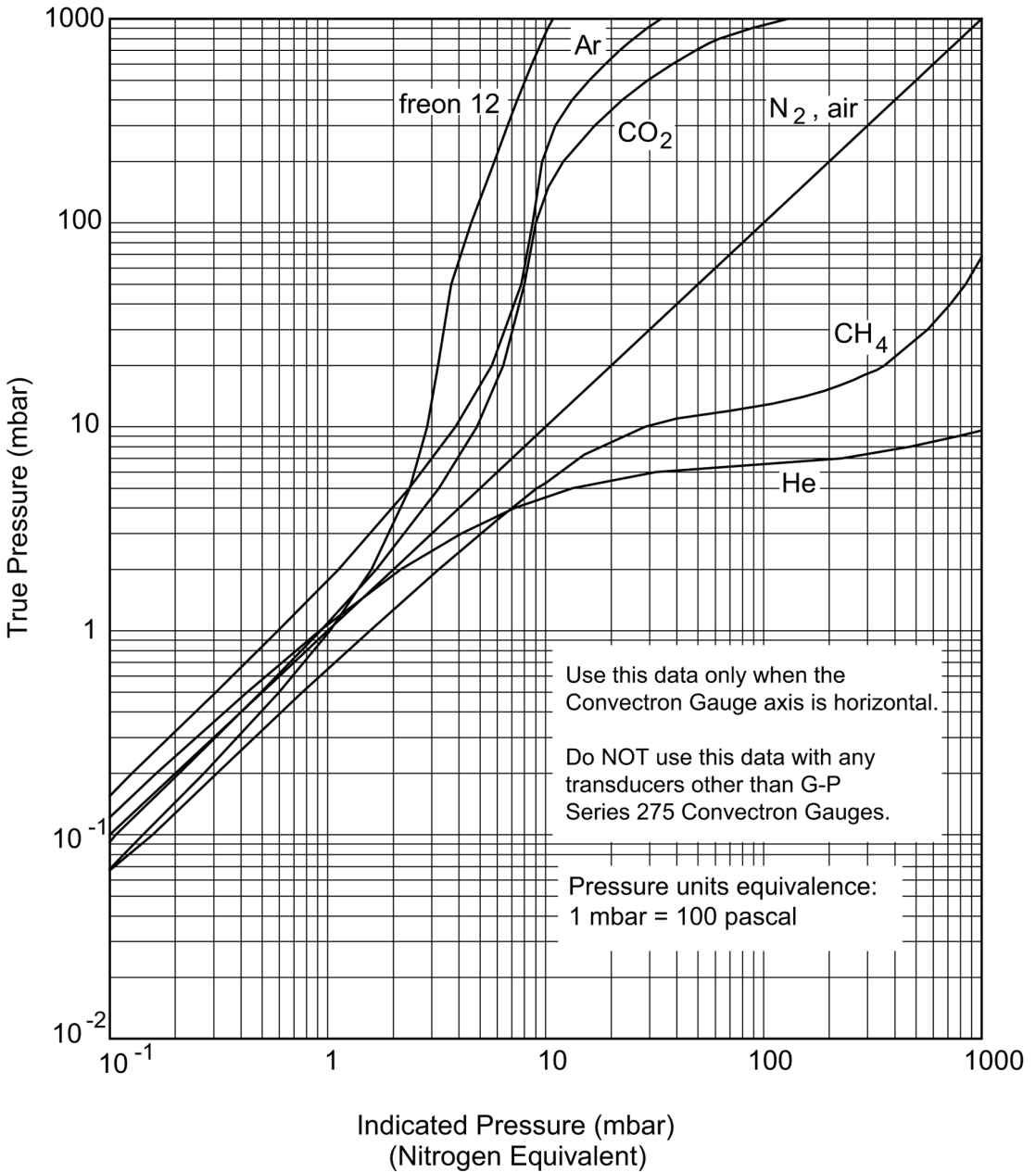
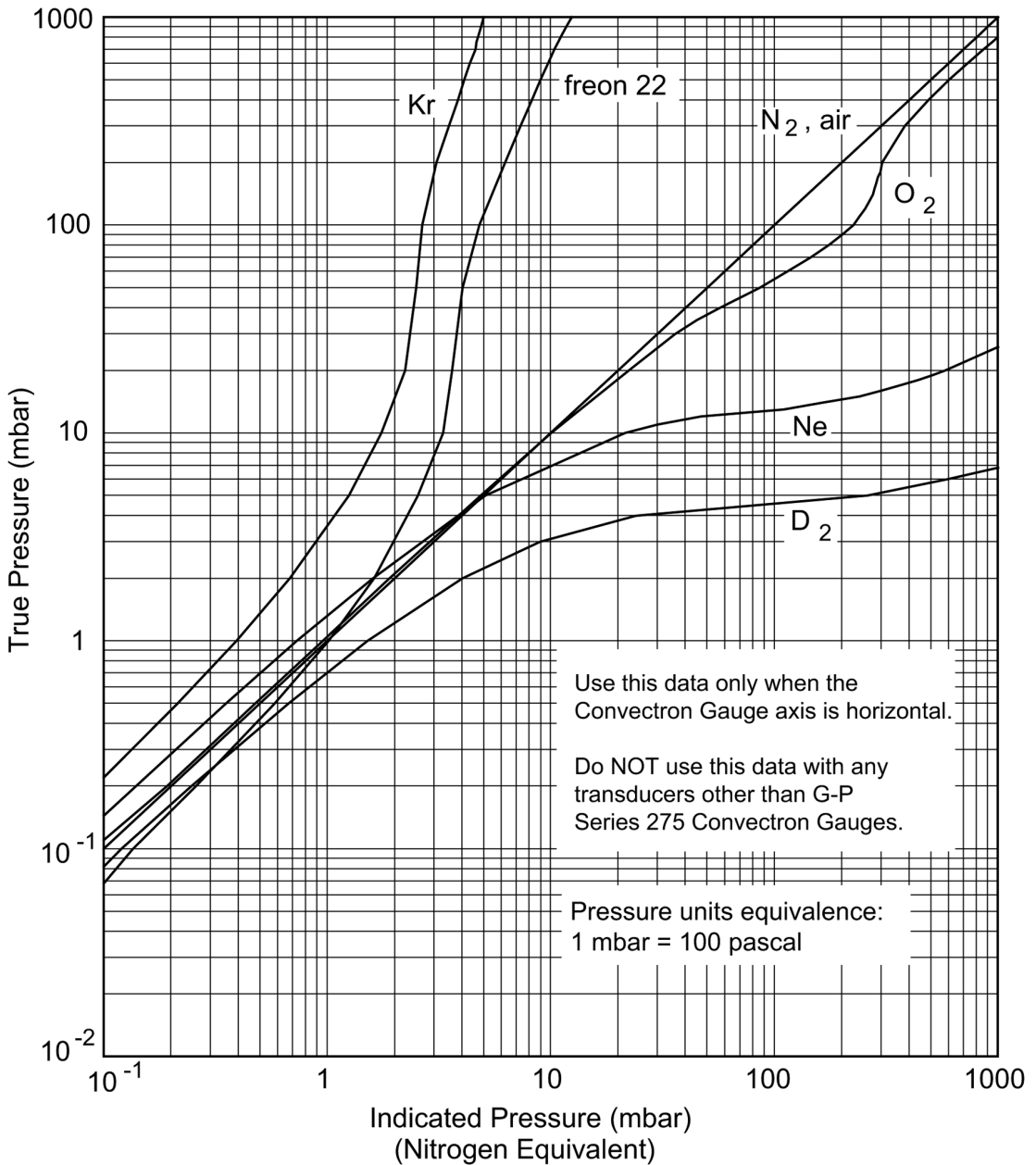



Figure 5-11 True Pressure versus Indicated Pressure for Commonly used Gases, 10<sup>-1</sup> to 1000 mbar



**5.7 Micro-Ion Gauge Auto ON/OFF**

 **WARNING**

**Failure to use accurate pressure conversion data for N<sub>2</sub> or air to other gases can cause an explosion due to overpressurization.**

If the controller will measure any gas other than N<sub>2</sub> or air, before connecting the controller to system control devices, adjust pressure outputs for the process gas that will be used.

If a Convectron Gauge is exposed to the same pressure environment as a Micro-Ion Gauge, then the Convectron Gauge may be used to automatically turn ON the Micro-Ion Gauge. Convectron Gauge A can turn ON the Micro-Ion Gauge. Micro-Ion Gauge automatic turn-on occurs when the Convectron Gauge pressure drops below the auto turn-on setpoint defined by the auto turn-on setting. The Micro-Ion Gauge will also be turned OFF automatically when the pressure rises slightly above the auto turn-on setpoint if the electrometer overpressure setpoint does not trip first. The automatic ON/OFF function will execute only once per setpoint crossing. For example, if the Micro-Ion Gauge is turned OFF manually when below the setpoint, the auto-on function will not turn it back ON until the Convectron Gauge pressure has risen above the setpoint and then dropped below it again.

**5.8 Filament Auto ON**

1. Place the IG Auto switch (Figure 5-12) on the Convectron Gauge module in the set position. (The Convectron pressure should be at a higher pressure than the setpoint pressure when setting the Turn ON setpoint.)
2. The existing turn ON pressure is displayed on the A display.
3. Set the desired turn ON pressure with the auto set adjustment.
4. To deactivate this capability place the IG AUTO switch in the OFF position.

*NOTE: Do not leave the IG AUTO switch in the set position, as this prevents pressure from being displayed.*



Figure 5-12 IG Auto Switch for Convectron Gauge

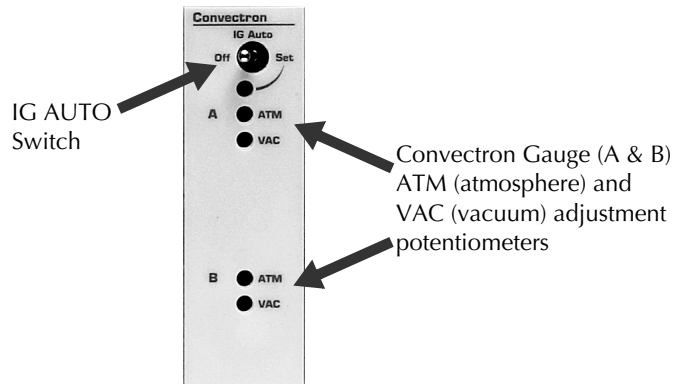

## 5.9

### Gauge Zero and Atmospheric Pressure Adjustment



## WARNING

**Failure to use accurate pressure conversion data for N<sub>2</sub> or air to other gases can cause an explosion due to overpressurization.**

If the controller will measure any gas other than N<sub>2</sub> or air, before connecting the controller to system control devices, adjust pressure outputs for the process gas that will be used.

Each Convectron gauge is individually computer-calibrated for N<sub>2</sub>. Adjustment of the zero should not be necessary unless readout accuracy is required below  $1 \times 10^{-3}$  Torr. Adjustment of the atmospheric indication should not be necessary unless compensating for long cables or variations in mounting orientation. The Convectron gauge has a stable, temperature compensated design and each Controller is also calibrated to provide accurate readout of N<sub>2</sub> pressure with any gauge when properly installed with the gauge axis horizontal.

1. Evacuate Convectron gauge A to a pressure known to be less than  $1 \times 10^{-4}$  Torr.
2. With power ON and at vacuum less than  $1 \times 10^{-4}$  Torr for at least 15 minutes, adjust VAC for gauge A (see Figure 5-12) until display A indicates 0.0 0 Torr/mbar or 0.0 0 pascal, not 1.0 -4, 1.0 -2, or 0.0 -0.
3. Let the pressure in the gauge increase to the local atmospheric pressure.
4. Read the local atmospheric pressure on a nearby, accurate barometer.
5. With power ON, adjust the ATM until the display on the front of the

controller indicates the local atmospheric pressure in the pressure units you have selected.

*NOTE: 1 atmosphere at sea level is  $7.6 \times 10^{+2}$  Torr;  
 $1.0 \times 10^{+3}$  mbar;  $1.0 \times 10^{+5}$  pascal.*

6. Repeat this procedure for Convector Gauge B.

**5.10 Convector Gauge Analog Output Signal**

If the Convector gauge capability is installed, a voltage output signal proportional to the common logarithm of the pressure indication is provided on the rear panel of the Convector gauge module via a standard 1/8 in. miniature phono jack. See Figure 5-13.

If graphed on loglinear axes, the output voltage is linear with respect to the log of pressure. The analog output is 1 V per decade of pressure with a factory adjusted output of 0 V at  $1.0 \times 10^{-4}$  Torr. See Figure 5-14.

Offset adjustments are provided on the top edge of the Convector gauge module that allow shifting the voltage corresponding to  $1 \times 10^{-4}$  Torr between -7 V and +1 V.

**Figure 5-13 Convector Module and Rear Panel**

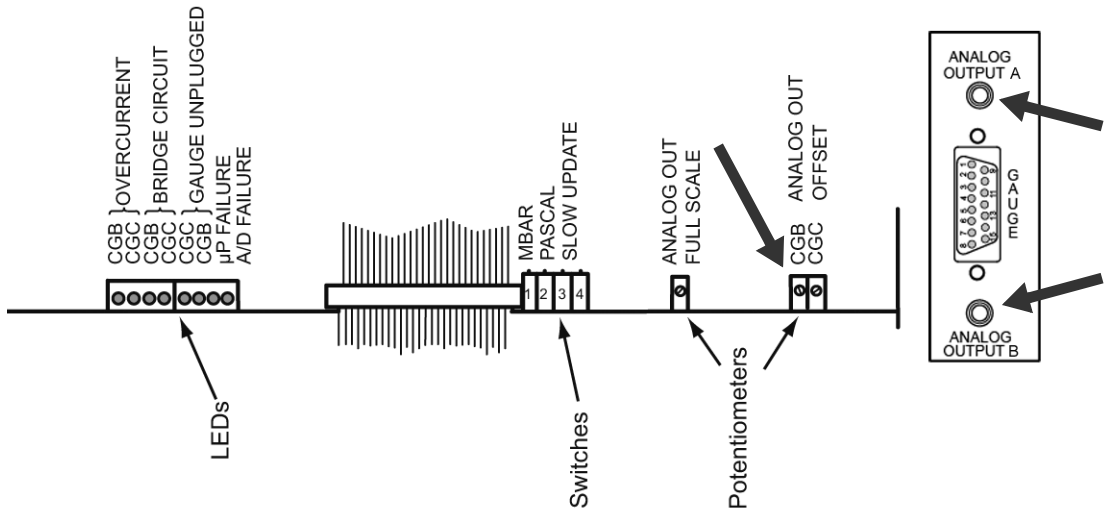
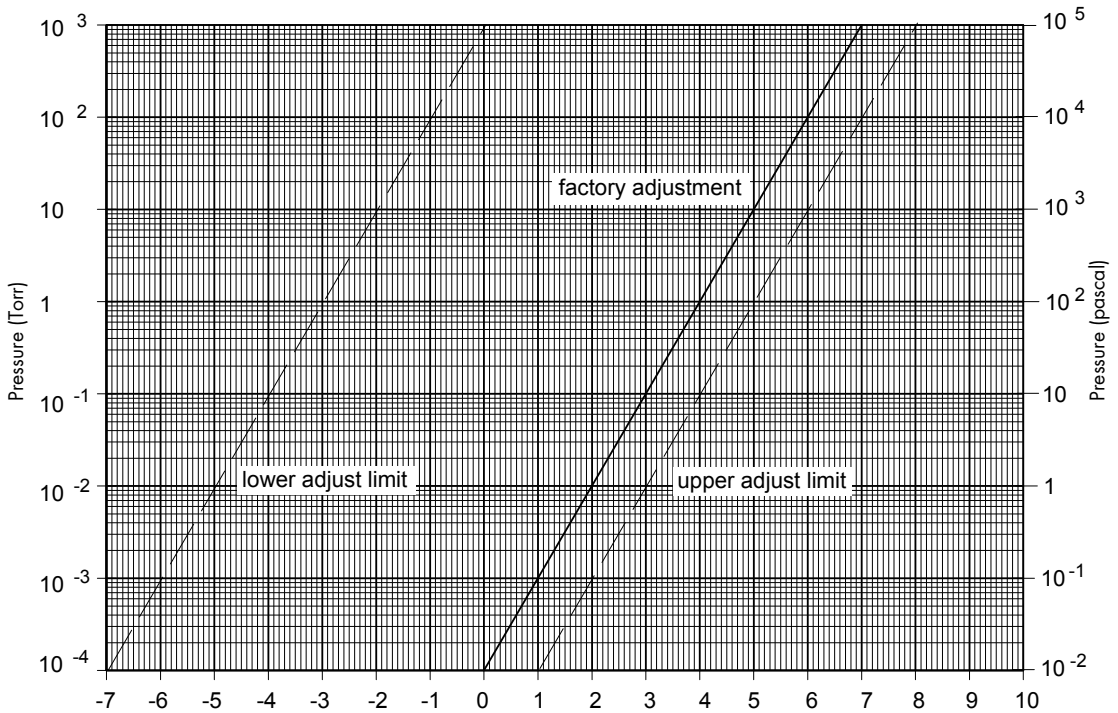

Figure 5-14 Convectron Gauge Analog Output versus Pressure



The voltage signal is smooth and continuous throughout all the decades of pressure measurement. This format is useful for computerized data acquisition because a simple equation (finding the common antilogarithm) may be programmed to calculate pressure from the voltage output.

The equation is:  $P_i = 10^{V-4}$  Torr/mbar, or  $P_i = 10^{V-2}$  pascal

where  $P_i$  = pressure indication,  
 $V$  = analog output voltage

and: the offset is factory adjusted for 0 V at  $1 \times 10^{-4}$  Torr ( $1 \times 10^{-2}$  pascal)

If the offset has been adjusted to other than 0V at  $10^{-4}$  Torr ( $10^{-2}$  pascal), then the exponent value must be forced to -4 (-2 for Pa) when the pressure is at  $1.0 \times 10^{-4}$  Torr ( $1 \times 10^{-2}$  pascal) by adding or subtracting a number other than -4 from the value of  $V$ .

For example, if the offset has been adjusted so that the output voltage is -7 V at  $1 \times 10^{-4}$  Torr ( $1 \times 10^{-2}$  pascal), then +3 (+5 for pascal) must be used in the

equation instead of  $-4$ , i.e.,  $P = 10^{(-7+3)}$ . Furthermore for the same offset, if the pressure were, say,  $1 \times 10^{-2}$  Torr, then the output voltage would be  $-5$  V. The pressure would be calculated as  $P = 10^{(-5+3)}$ .

**5.11 Preparing for Capacitance Manometer Operation**

The capacitance manometer pressure is read in the third display line of the 358 Controller. The accompanying Convectron gauge is read in the second display line. If the cable is disconnected, the capacitance manometer will read Zero pressure.

See *Connecting a Capacitance Manometer* on page 60 for additional information regarding initial installation and setup and adjustments of the capacitance manometer module.

**Figure 5-15 Convectron/Capacitance Manometer Module Panel**

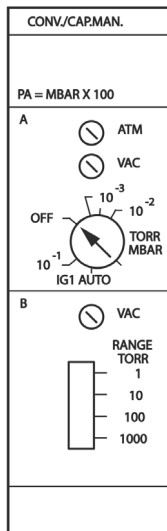

Use the IG AUTO potentiometer to set the auto turn ON pressure for the Micro-Ion Gauge. The IG AUTO turn-on potentiometer is marked with rough pressure calibration markings. To set the pressure at which the Micro-Ion Gauge will turn ON with falling pressure, and OFF with rising pressure, simply adjust the potentiometer to point to the desired pressure.

More precise control can be achieved by fixing the system pressure at the desired auto turn-on pressure, and adjusting the potentiometer slowly until the gauge comes ON.

To disable the auto turn on function, adjust the auto turn-on potentiometer completely counter-clockwise (OFF).

**Initial Transducer Calibration**

When first installed, the transducer zero-adjust should be set using a voltmeter to read Zero when at a system pressure below the minimum pressure range of the transducer. Refer to the documentation accompanying your capacitance manometer transducer for instructions on this procedure. You should also at this time adjust the VAC on the 358 controller, with the gauge not attached to the controller, per the instructions below. After this initial setup has been performed, the routine fine-tuning of the transducer zero can be performed with the module front panel VAC (zero) adjust potentiometer. The zero can be adjusted to  $0 \pm 200$  mV.

**Set The Controller Zero (Initial Controller Setup)**

1. Disconnect the capacitance manometer cable either at the gauge head or at the controller.
2. Adjust the vacuum potentiometer (Figure 5-15) until the third display line shows a single "0". If the adjustment is turned too far, a minus sign will appear in the display. This proper calibration is achieved when only the "0" appears.

**Zero the Controller with the Transducer**

1. Be sure the transducer was zeroed properly on initial installation, see your transducer documentation. Connect the cable from the 358 Controller to the capacitance manometer transducer.
2. Evacuate your system to one decade below the minimum rated pressure of your transducer.
3. Adjust the vacuum potentiometer (Figure 5-15) until the third display line shows a single "0". If the adjustment is turned too far, a minus sign will appear in the display. This proper calibration is achieved when only the "0" appears.

**5.12 Preparing for Process Control Operation****Setpoint Display and Adjustment**

Setpoints are stored in non-volatile memory, and are specified by a 2-digit mantissa and 2-digit exponent. They may be set anywhere in the range  $1 \times 10^{-12}$  to  $9 \times 10^5$ . This allows for the entire pressure range of all supported transducer types and systems of units.

The setpoint is compared directly to the display data, so units of measure are implicit. Changing the units switch on the gauge control modules will not change the stored setpoints. They must be reprogrammed in the new system of units.

There is a programmed 10% hysteresis on each process control setpoint. For example, with a pressure setpoint of  $6.3 \times 10^{-6}$  Torr the relay will activate when the display reaches  $6.2 \times 10^{-6}$  Torr (for falling pressure) and will deactivate when the pressure rises to one significant digit above the setpoint plus 10%, i.e.,  $6.3 \times 10^{-6} + 0.6 \times 10^{-6} + 0.1 \times 10^{-6}$  or  $7.0 \times 10^{-6}$  Torr. For setpoints where the 2nd digit is 0.5 or greater the 10% value is rounded up.

For example, if the setpoint is programmed to  $6.6 \times 10^{-6}$  Torr the relay will activate at  $6.5 \times 10^{-6}$  Torr (on falling pressure) and will deactivate when the pressure rises to  $6.6 \times 10^{-6} + 0.7 \times 10^{-6} + 0.1 \times 10^{-6}$  or  $7.4 \times 10^{-6}$  Torr.

Since the process control and computer interface modules derive their pressure data directly from the display bus, they will be unable to update their pressure data while setpoints are being displayed. They will not mistakenly interpret setpoint data as pressure data, but will simply retain the last displayed pressure data until the SET key is released.

### Manual Override

The 3-position switches on the front of the process control module allow override of the programmed setpoints at any time. When moved to the right, the relay is activated. When moved to the left, the relay is deactivated. When left in the center position, the relay is controlled automatically.

**Figure 5-16 Process Control Module Front Panel**

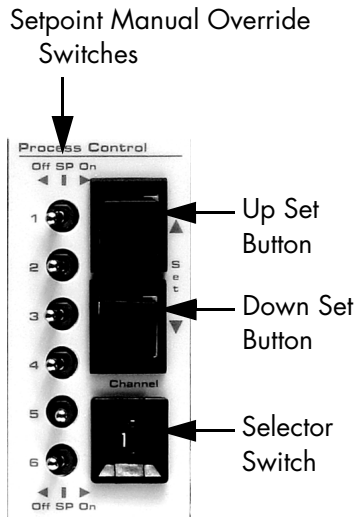

### To Display a Setpoint

1. Be sure the "CAL" switch of the electrometer module is in its OFF position, or the calibration data in display line 1 will conflict with the display of setpoints 1 and 2.
2. Set selector switch 1 to the number of the channel you wish to display.
3. Press the setpoint display/set button (either the Up or Down button) and release. The setpoint will appear for 2 seconds in the corresponding display.

**To Modify a Setpoint**

1. Set the selector switch to the number of the channel you wish to modify (see Figure 5-16).
2. Press and hold one of the setpoint Set pushbuttons for the direction you wish the setpoint to change.
3. The setpoint will scroll until the switch is released. It will scroll slowly until a decade boundary is crossed and then will speed up to facilitate rapid changes across many decades. Release the switch when you have entered the desired decade, and then re-depress it to scroll slowly within the decade to reach the exact setpoint needed.

After the setpoint switch is released, the display will return to pressure data after two seconds. At this time, the new setpoint will be deposited in non-volatile memory.

If the ion gauge is OFF, PC relays 1 and 2 will deactivate.

### 5.13 Preparing to use RS-232 Computer Interface

Consult the user's manual for the host computer to be sure the protocol used is in accord with that established via the switch configuration you have chosen for the controller RS-232 module.

Communication with the controller VGC is via ASCII strings. A message to the controller consists of a command and a command modifier, followed by a terminator. The message may contain leading spaces, and the command and modifier may optionally be separated by spaces or commas. No spaces may appear within the command or the modifier, only between them.

The terminator expected by the controller is an ASCII carriage-return and line-feed, denoted here by CRLF. A carriage return, code CR, is hex 0D or decimal 13. A line feed, code LF, is hex 0A or decimal 10. The carriage-return is optional, and messages terminated with only the line-feed will be accepted. Note that the CRLF terminator is, in general, appended automatically by the host computer's interface software to the message string supplied by the user.

If extra characters are found in the message after it has been successfully interpreted but before the terminator, they will be ignored.

All characters should be upper-case.

All messages to the controller will receive a reply, consisting of an ASCII string terminated with CRLF. Numbers will be returned in the format X.XXE±XX.

**Command Syntax for  
RS-232 Computer  
Interface**

<b>DG</b>	Definition:	Turn degas ON or OFF.
	Modifiers:	ON or OFF
	Response:	OK if command accepted, or INVALID if rejected.
	Example:	
	From computer:	DG ON CRLF
	From controller:	OKCRLF
		<ul style="list-style-type: none"><li>• Command is INVALID if the Ion gauge is OFF.</li><li>• A response to the DG ON command of OK indicates only that a signal requesting degas has been sent to the electrometer. Degas may fail to activate if the pressure is above <math>5 \times 10^{-5}</math> Torr. Use the DGS command (see below) to verify that degas has been successfully initiated.</li></ul>
<b>DGS</b>	Definition:	Display degas status.
	Modifiers:	None
	Response:	ASCII 1 if degas is ON, 0 if degas is OFF.
	Example:	
	From computer:	DGS CRLF
	From controller:	1CRLF (Indicating degas is ON.)
<b>DS</b>	Definition:	Display pressure reading.
	Modifiers:	IG or CG1 or CG2.
	Response:	ASCII string representing the pressure for the selected gauge.
	Example:	
	From computer:	DS IG CRLF
	From controller:	1.20E-07CRLF
		<ul style="list-style-type: none"><li>• The DS IG command will return pressure from the top display if either filament is ON, and 9.90E+09 if the gauge is OFF.</li><li>• The DS CG1 command will return pressure from the middle display.</li><li>• The DS CG2 command will return pressure from the bottom display.</li></ul>



<b>IG1</b>	<p>Definition: Turn the Ion gauge ON or OFF.</p> <p>Modifiers: ON or OFF</p> <p>Response: OK if command accepted, INVALID if rejected.</p> <p>Example:</p> <p>From computer: IG1 ON CRLF</p> <p>From controller: OKCRLF</p> <ul style="list-style-type: none"> <li>• The IG1 ON command will be rejected as INVALID if the Ion gauge is already ON, and IG1 OFF will be rejected if the Ion gauge is already OFF.</li> <li>• A response to the IG1 ON command of OK indicates only that a signal requesting that the ion gauge be turned ON has been sent to the electrometer. The tube may fail to come on, e.g., if the system pressure is too high or if the tube is disconnected. If the tube is OFF (or in its first few seconds of operation after being turned ON), a pressure of 9.99E+9 will be returned.</li> </ul>
<b>IG2</b>	Identical to IG1 - performs the same functions as IG1
<b>PCS</b>	<p>Definition: Display process control channel status.</p> <p>Modifiers: 1 or 2 or 3 or 4 or 5 or 6 or B or none.</p> <p>Response: Depends on modifier:</p> <p>Single digit (1 through 6); response = single ASCII digit, 0 if the corresponding relay is inactive, 1 if active. See Example 1.</p> <p>B; response = a byte of data with bits 0 through 5 set/clear according to whether the corresponding relay is active/inactive. Bit 6 will always be set to guarantee that the returned byte will not appear as a terminator byte. See Example 2.</p> <p>None or Absent; response will be a string of 6 ASCII zeroes and ones separated by commas, giving the status of all six channels. See Example 3.</p> <p>Examples:</p> <p>Assume that channels 1-3 are active, and 4-6 are inactive:</p> <ol style="list-style-type: none"> <li>1. From computer: PCS 1 CRLF</li> <li>From controller: 1CRLF</li> </ol>

2. From computer: PCS B CRLF  
From controller: GCRLF

(Note that ASCII "G" corresponds to the bit pattern 01000111 and represents the status of the PC channels in bits 0 through 5).

3. From computer: PCS CRLF  
From controller: 1,1,1,0,0,0 CRLF

#### 5.14 RS-232 Error Messages

If an error is found in the incoming message, the following messages will be returned in place of the normal response:

##### **OVERRUN ERROR**

Returned if the incoming message overflows the controller's buffer. This may indicate a flaw in the host software.

##### **PARITY ERROR**

Returned if the parity of a byte in the incoming message does not match that programmed by the switches.

##### **SYNTAX ERROR**

Returned if the message fails to parse as a valid controller command. Could also result from failure to assert DCD during transmission to the controller.

#### 5.15 Preparing to Use RS-485 Computer Interface

Consult the user's manual for the host computer to be sure the protocol used is in accord with that established via the switch configuration you have chosen for the RS-485 module.

Communication is via ASCII strings. A message consists of a start character "#", an address, a command, and a command modifier, followed by a terminator. The message may contain leading spaces, and the command and modifier may optionally be separated by spaces or commas. No spaces may appear within the command or the modifier, only between them.

The address expected is programmed via the switch settings on the rear of the module and the internal switches. The syntax is "#AA" where AA is an ASCII representation of the hex address of the VGC.

The terminator expected is an ASCII carriage return denoted here by CR. Note that the terminator is sometimes appended automatically, by the host computer's interface software, to the message string supplied by the user. If extra characters are found in the message after it has been successfully interpreted but before the terminator, they will be ignored.

All messages will receive a reply, consisting of an ASCII string terminated with CR. Numbers will be returned in the format X.XXE±XX.

Messages may use upper or lower case alpha characters. The VGC will always respond with upper case characters.

## Command Syntax for RS-485 Computer Interface

<b>DG</b>	<p>Definition: Turn degas ON or OFF.</p> <p>Modifiers: ON or OFF.</p> <p>Response: OK if command accepted, or INVALID if rejected.</p> <p>Example:</p> <p>From computer: #AADG ON CR</p> <p>From controller: OKCR</p> <ul style="list-style-type: none"> <li>• Command is INVALID if the Ion gauge is OFF.</li> <li>• A response to the DG ON command of OK indicates only that a signal requesting degas has been sent to the electrometer. Degas may fail to activate, e.g., if the pressure is above <math>5 \times 10^{-5}</math> Torr. Use the DGS command (see below) to verify that degas has been successfully initiated.</li> </ul>
<b>DGS</b>	<p>Definition: Display degas status.</p> <p>Modifiers: None.</p> <p>Response: ASCII 1 if degas is ON, 0 if degas is OFF.</p> <p>Example:</p> <p>From computer: #AADGSCR (Spaces may be omitted.)</p> <p>From controller: 1CR (Indicating degas is ON)</p>
<b>DS</b>	<p>Definition: Display pressure reading.</p> <p>Modifiers: IG or CG1 or CG2</p> <p>Response: ASCII string representing the pressure for the selected gauge.</p> <p>Example:</p> <p>From computer: #AADS CG1 CR</p> <p>From controller: 1.20E-03CR</p> <ul style="list-style-type: none"> <li>• The DS CG1 and DS CG2 commands are used to display the pressures from the second and third display lines.</li> <li>• If the ion gauge is turned OFF, or is in its first few seconds of operation, the controller will return 9.90E+09.</li> <li>• The DS IG command will return pressure if the gauge is ON, and 9.90E+09 if it is OFF.</li> </ul>

<b>IG1</b>	Definition:	Turn the Ion gauge ON or OFF.
	Modifiers:	ON or OFF
	Response:	OK is command accepted, INVALID if rejected.
	Example:	
	From computer:	#AAIG1 ON CR
	From controller:	OKCR
		<ul style="list-style-type: none"><li>• The IG ON command will be rejected as INVALID if the Ion gauge is already ON, and IG OFF will be rejected if the Ion gauge is already OFF.</li><li>• A response to the IG1 ON command of OK indicates only that a signal requesting that the Ion gauge be turned ON has been sent to the electrometer. The tube may fail to come on, e.g., if the system pressure is too high or if the tube is disconnected. To verify that the Ion gauge is ON, use the DS IG1 command. If the tube is OFF (or in its first few seconds of operation after being turned ON) a pressure of 9.90E+9 will be returned.</li></ul>
<b>IG2</b>		Identical to IG1 - performs the same functions as IG1
<b>PCS</b>	Definition:	Display process control channel status
	Modifiers:	1 or 2 or 3 or 4 or 5 or 6 or B or none.
	Response:	Depends on modifier: Single digit (1 through 6); response = single ASCII digit, 0 if the corresponding relay is inactive, 1 if active.  B; response = a byte of data with bit 0 through 5 set/clear according to whether the corresponding relay is active/inactive. Bit 6 will always be set to guarantee that the returned byte will not appear as a terminator byte.  None or Absent; response will be a string of 6 ASCII zeroes and ones separated by commas, giving the status of all six channels.

Examples:

Assume that channels 1 through 3 are active, and 4 through 6 are inactive:

From computer: #AAPCS 1 CR

From controller: 1CR

From computer: #AAPCS B CR

From controller: GCR

The ASCII "G" corresponds to the bit pattern 01000111 and represents the status of the PC channels).

From computer: #AAPCS CR

From controller: 1,1,1,0,0,0CR

## 5.16 RS-485 Error Messages

If an error is found in the incoming message, the following messages will be returned in place of the normal response:

### **OVERRUN ERROR**

Returned if the incoming message overflows the buffer. This may indicate a flaw in the host software.

### **PARITY ERROR**

Returned if the parity of a byte in the incoming message does not match that programmed by the switches.

### **SYNTAX ERROR**

Returned if the message fails to parse as a valid command.



The instructions in this chapter assume the instructions for Setup, Installation, and Preparing for Operation have been completed. See *Chapter 2*, *Chapter 3*, and *Chapter 4*.

For theories of operation for the Micro-Ion Gauge, Convectron Gauge, electrometer, capacitance manometer, and process control modules, see *Chapter 7*.

## 6.1 Controller Operation

### Turning the Controller ON

1. Press the top half of the power ON switch on the rear panel of the Controller (see Figure 6-1).

Figure 6-1 Power ON Switch

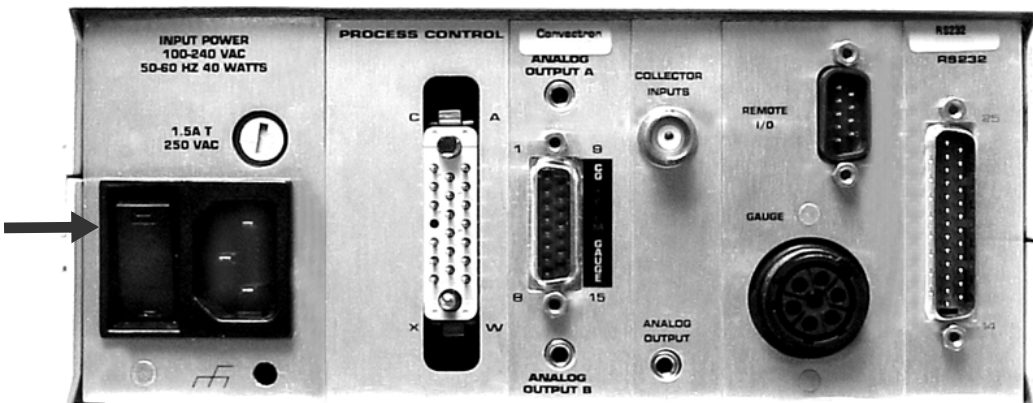

2. When the power switch is ON, the Micro-Ion Gauge pressure is displayed on line Micro-Ion Gauge and Convectron Gauge pressures are displayed on lines A and B of the display on the front panel of the Controller (see Figure 6-2). Display formats for the Convectron Gauge pressures are given in Table 6-1.

Figure 6-2 Controller Front Panel

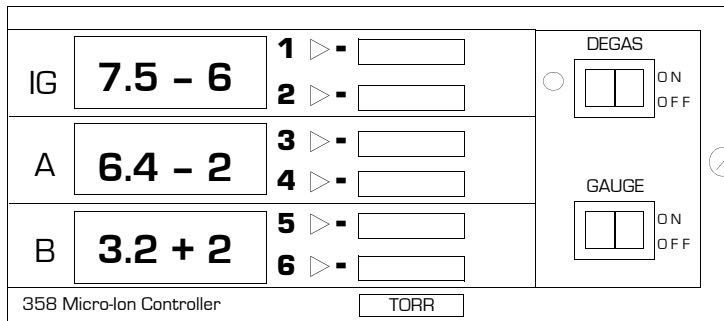

3. If you have Convectron Gauge capability installed and have prepared your system for automatic operation of the Micro-Ion Gauge per *Micro-Ion Gauge Auto ON/OFF* on page 80, the Micro-Ion Gauge will turn ON and OFF automatically.
4. For manual operation, press the front panel GAUGE momentary rocker switch. See Figure 6-2. The pressure in the Micro-Ion gauge will be displayed on the Micro-Ion gauge line of the display in the chosen pressure units.
5. To degas the Micro-Ion Gauge (the gauge must be ON and the pressure within the Micro-Ion Gauge must be below  $5 \times 10^{-5}$  Torr), depress the DEGAS momentary rocker switch on the Controller.
6. When the filament is nearing the end of its useful lifetime or is badly contaminated, the LED indicator next to the DEGAS switch on the front panel will blink during degassing. This is an indication that the filament emission properties have deteriorated. This may be due to contamination which has temporarily "poisoned" the filament coating, or to long term permanent erosion of the coating.

If this condition does not disappear after a few days of operation at clean high vacuum or UHV, it is an indication that the filament is approaching its end of life.



7. Stable pressure measurement requires that all the environmental parameters in, on, and around the vacuum gauge and vacuum system remain unchanged during measurement. Therefore, never attempt meaningful measurements immediately after turning on the Micro-Ion Gauge or immediately after degassing the gauge. Permit sufficient time for the environmental parameters to stabilize.

**Table 6-1 Convectron Gauge Display Formats**

Units	Display Format	Pressure	Example
Torr	scientific	< 1 Torr	3.2-3 Torr
	floating point	> 1 Torr	7.1 Torr
mbar	scientific	< 1 mbar	5.1-2 mbar
	scientific	> 1 mbar	8.8+1 mbar
	scientific	> 999 mbar	1.2+3 mbar
pascal	scientific	< 1 pascal	7.2-1 pascal
	scientific	> 1 pascal	7.8+1 pascal
	scientific	> 999 pascal	1.2+4 pascal

## 6.2 Micro-Ion Gauge ON/OFF

The Micro-Ion Gauge can be turned ON or OFF by the front panel GAUGE “momentary” rocker switch or by the remote input, the Convectron Gauge set point, or the computer interface command.

To turn ON the Micro-Ion Gauge from the front panel, press the GAUGE momentary rocker switch. See Figure 6-2. To turn it OFF, press the GAUGE rocker switch again. After a 3-second delay, the Micro-Ion Gauge pressure will be displayed.

## 6.3 Degas ON/OFF

The EB (electron bombardment) degas may be turned ON or OFF by the front panel DEGAS “momentary” rocker switch, (see Figure 6-2), or the remote input. To turn degas ON, press the DEGAS momentary rocker switch. To turn it OFF, press the DEGAS momentary rocker switch again. Degas automatically turns OFF and returns to normal emission in 2 minutes.

Degas “ON” indication is by the degas LED adjacent to the DEGAS rocker switch on the front panel (see Figure 6-2). Degas cannot be activated unless the Micro-Ion Gauge has been turned ON and indicated system pressure is below  $5 \times 10^{-5}$  Torr. This prevents degas turn-on at pressures where emission can not be established or where degas is of no practical use. Micro-Ion Gauge pressure measurement is displayed during degas, but it is not an accurate measurement during the degas cycle.

#### 6.4 Special Considerations for Use Below $10^{-3}$ Torr

During a fast pumpdown from atmosphere, thermal effects will prevent the Convectron gauge from tracking pressure accurately below  $1 \times 10^{-3}$  Torr. After about 15 minutes, indications in the  $1 \times 10^{-4}$  range will be valid and response will be rapid.

In the  $1 \times 10^{-4}$  Torr range, the indication is accurate to about  $\pm 0.1$  milliTorr provided the instrument has been carefully zeroed at vacuum. See *Gauge Zero and Atmospheric Pressure Adjustment* on page 81 for vacuum and atmosphere calibration procedures. For accurate use in the  $1 \times 10^{-4}$  range, zeroing should be repeated frequently.

Convectron pressure readings in the  $1 \times 10^{-4}$  Torr range may differ from those of the ion gauge, since ion gauges usually lose sensitivity near their upper pressure limits.

#### 6.5 Gauge Electrometer Operation

Figure 6-3 Electrometer Module Front Panel

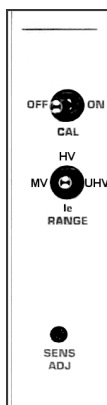

##### Displaying Sensitivity with Calibration Switch

The CAL switch is used for displaying pressure or gauge sensitivity. It is activated by setting to the ON position. The data displayed will depend on the state of the Micro-Ion Gauge tube:

If the Micro-Ion Gauge is OFF, setting the switch ON displays the Micro-Ion Gauge sensitivity in the display. This will be in scientific notation. If the Micro-Ion Gauge is ON, the switch has no effect and pressure will be displayed.

*NOTE: Do NOT leave the calibration switch in the ON position after viewing the sensitivity - otherwise, the displayed reading might be mistaken for the actual pressure reading.*

##### Emission Range Switch

The emission range switch selects between three emission ranges; 20 microamperes (MV), 1 milliamperes (HV), or 4 milliamperes (UHV).

In general, higher emissions are used at lower pressures. If you are measuring very low pressures the 4 mA range is best. Lower emissions will increase tube life.

The overpressure shutdown point will change inversely proportional to the emission range. See Table 3-1 on page 30.

#### Sensitivity Adjustment

The sensitivity adjustment (see Figure 6-3) on the electrometer module is used to match gauges of different sensitivities. The Calibration switch on the electrometer module must be ON with the Micro-Ion Gauge OFF to view sensitivity during the adjustment.

The controller is preset for a tube sensitivity of 20/Torr which is typical for the Micro-Ion Gauge. The approximate range of the adjustment is 3 to 50/Torr.

#### Relative Gas Sensitivities

Sensitivity depends on the gas being measured as well as the type of Micro-Ion Gauge tube. Table 6-2 on page 99 lists the relative gauge sensitivities for common gases. These values are from NASA Technical Note TND 5285, *Micro-Ion Gauge Sensitivities as Reported in the Literature*, by Robert L. Summers, Lewis Research Center, National Aeronautics and Space Administration. Refer to this technical note for further definition of these average values and for the gauge sensitivities of other gases.

To adjust the controller to direct reading for gases other than air or N<sub>2</sub> during Micro-Ion Gauge operation, calculate the sensitivity K<sub>x</sub> for gas type x as follows:

$$K_x = (R_x)(KN_2)$$

Where KN<sub>2</sub> is the gauge sensitivity for N<sub>2</sub> and R<sub>x</sub> is found from Table 6-2 on page 99.

**Table 6-2 Relative Gas Sensitivities**

Gas	R <sub>x</sub>	Gas	R <sub>x</sub>
He	0.18	H <sub>2</sub> O	1.12
Ne	0.30	NO	1.16
D <sub>2</sub>	0.35	Ar	1.29
H <sub>2</sub>	0.46	CO <sub>2</sub>	1.42
N <sub>2</sub>	1.00	Kr	1.94
Air	1.00	SF	2.50
O <sub>2</sub>	1.01	Xe	2.87

**6.6 Filament Selection for Electrometer Module**

The Filament Select switch (see Figure 6-4) is used to operate each filament individually or both in series.

Normally only one filament should be selected.

During degas, selecting the BOTH position will clean up the tube more satisfactorily allowing for a lower ultimate pressure reading.

**Figure 6-4 Filament Select Switch**

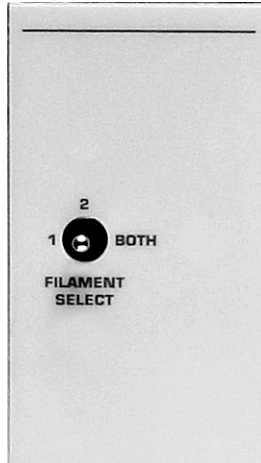

## 7.1 Micro-Ion Gauge Theory of Operation

The functional parts of a typical Micro-Ion Gauge are the filament (cathode), grid (anode) and ion collector, which are shown schematically in Figure 7-1. These electrodes are maintained by the gauge Controller at +30, +180, and 0 V, relative to ground, respectively.

The filament is heated to such a temperature that electrons are emitted, and accelerated toward the grid by the potential difference between the grid and filament. Most of the electrons eventually collide with the grid, but many first traverse the region inside the grid one or more times.

**Figure 7-1 Micro-Ion Gauge Schematic**

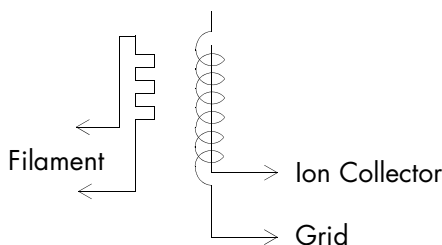

When an energetic electron collides with a gas molecule an electron may be dislodged from the molecule leaving it with a positive charge. Most ions are then accelerated to the collector. The rate at which electron collisions with molecules occur is proportional to the density of gas molecules, and hence the ion current is proportional to the gas density (or pressure, at constant temperature).

The amount of ion current for a given emission current and pressure depends on the Micro-Ion Gauge design. This gives rise to the definition of Micro-Ion Gauge “sensitivity,” frequently denoted by “K.”

$$K = \frac{\text{Ion current}}{\text{Emission current} \times \text{Pressure}}$$

The Series 355 Micro-Ion Gauge has a sensitivity of 20/Torr when used with nitrogen or air. Sensitivities for other gases are given in *Relative Gas Sensitivities* on page 99.

The Micro-Ion Gauge Controller varies the heating current to the filament to maintain a constant electron emission, and measures the ion current to the collector. The pressure is then calculated from these data.

## 7.2 Convectron Gauge Theory of Operation

The Convectron Gauge transducer is represented in Figure 7-2 as R1, R2, R3, and R4. These four resistances form the legs of a bridge circuit, with R1 designating the sensor wire of the transducer. R2 is a resistive network in the tube that compensates for changes in the ambient temperature. At bridge null,  $R1 = R2 \times R3 / R4$ . If there are no changes in ambient temperature, the value of R1 is a constant and the bridge is balanced.

**Figure 7-2 Convectron Gauge Schematic**

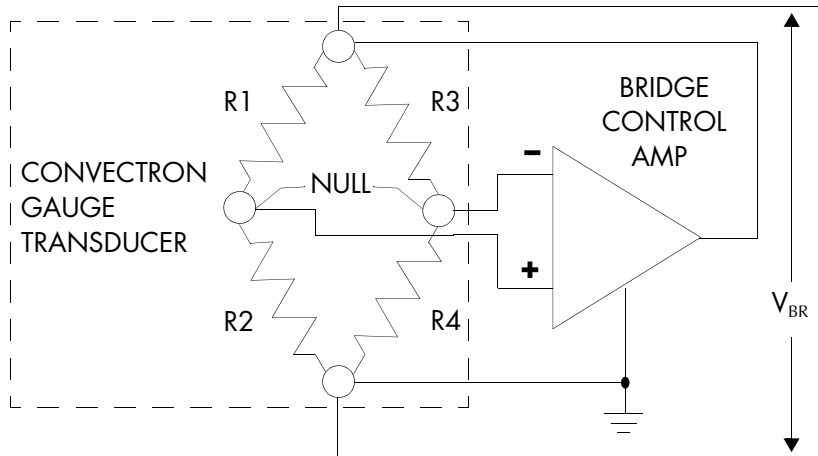

As the vacuum system pressure is decreased, there are fewer molecules in the system to conduct the heat away from the sensor wire causing the temperature and resistance of R1 to increase. The increased resistance of R1 causes the bridge to unbalance and a voltage is developed across the null terminals. The bridge control circuit senses the null voltage and decreases the voltage across the bridge until the null voltage is again zero. When the bridge voltage is decreased, the power dissipated in the sensor wire is decreased causing the resistance of R1 to decrease to its previous value. The opposite events happen for a pressure increase. The bridge voltage is a nonlinear function of pressure.

All materials have been chosen for ultra high vacuum service, corrosion resistance and bakeability to 150 °C. The gauge tube envelope is type 304 stainless steel. All metallic joints in the envelope are TIG welded. No solder is used within the envelope. The following materials are exposed to the vacuum. Type 304 stainless steel, Carpenter Alloy 52, Kovar®, Kapton®, gold-plated tungsten, borosilicate glass and Dow-Corning® 9015 glass. The blue trim cover is molded of Ultem® polyetherimide resin suitable for service to 150 °C.

- 7.3 Microcontrollers and Bus Structure**
- The electrometer module in the controller has a dedicated microcontroller with internal ROM, RAM, timing, and interrupt management functions. This architecture provides high performance at low cost with greater reliability and noise immunity than more complicated microprocessor systems using external buses and memory hardware.
- The microcontroller is equipped with a watchdog timer, which automatically generates a reset if the processor fails to fulfill timing “checkpoints” within its code. Interprocessor communication is accomplished via the display bus. These lines carry BCD-format pressure data that is used to generate the controller display.
- 7.4 Capacitance Manometer Theory of Operation**
- Within the capacitance manometer, a diaphragm is distorted by the pressure of the gas in the system under measurement. This diaphragm forms part of a capacitor, and its deflection causes changes in capacitance. Thus, the electrically measured capacitance is a measure of pressure. The device is very sensitive to the elastic properties of the metal of the diaphragm. For this reason, large pressure excursions, such as occur when the system is raised to atmospheric pressure, can cause offsets to the pressure reading. The diaphragm is also extremely sensitive to temperature effects, and although it may be held in a temperature controlled chamber, this temperature control is never perfect, resulting in further perturbations to the devices theoretical accuracy.
- Note that these perturbations are inherent in the capacitance manometer design and are not a property of the electronic module used to operate the transducer.
- Capacitance manometers are capable of exceptional accuracy, and read pressure independent of gas type, but are also subject to zero point drift, and must be calibrated at vacuum frequently if high accuracy is to be obtained. Refer to the manual for your transducer for instructions.
- 7.5 Process Control Theory of Operation**
- The process control module contains a dedicated microcontroller and a non-volatile memory chip for storage of the setpoints. The microcontroller compares the setpoints with the pressure display data on the display bus and makes a decision as to whether or not to activate a channel's relay.





### 8.1 Service Guidelines

Some minor difficulties are readily corrected in the field. Each module in the controller has fault indicator LEDs which help localize failures.

If a qualified service person makes repairs at the component level, repairs properly made with equivalent electronic parts and rosin core solder do not void the warranty.

Because the controller contains static-sensitive electronic parts, the following precautions must be followed when troubleshooting:

- Use a grounded, conductive work surface. Wear a high impedance ground strap for personal protection.
- Use conductive or static dissipative envelopes to store or ship static sensitive devices or printed circuit boards.
- Do not operate the product with static sensitive devices or other components removed from the product.
- Do not handle static sensitive devices more than absolutely necessary, and only when wearing a ground strap.
- Do not use an ohmmeter for troubleshooting MOS circuits. Rely on voltage measurements.
- Use a grounded, electrostatic discharge safe soldering iron.

This product was designed and tested to offer reasonably safe service provided it is installed, operated, and serviced in strict accordance with these safety instructions.



### WARNING

**Substitution or modifying parts can result in product damage or personal injury due to electrical shock or fire.**

- Install only those replacement parts that are specified by Granville-Phillips.
- Do not install substitute parts or perform any unauthorized modification to the controller.
- Do not use the controller if unauthorized modifications have been made.

**8.2 Customer service**

For customer service:

- Phone **1-303-652-4400** or **1-800-776-6543** within the USA.
- Phone **1-800-367-4887** 24 hours per day, 7 days per week within the USA.
- Email *co-csr@brooks.com*
- For Global Customer Support, go to [www.brooks.com](http://www.brooks.com), click on Contact Us, then click on Global Offices to locate the Brooks Automation office nearest you.

**8.3 Damage Requiring Service**

Disconnect this product from the power source and refer servicing to qualified service personnel if any the following conditions exist:

- A gauge cable or plug is damaged.
- Liquid has been spilled onto, or objects have fallen into, the product.
- The product has been exposed to rain or water.
- The product does not operate normally even if you have followed the Operation Instructions. Adjust only those controls that are covered in the instruction manual. Improper adjustment of other controls may result in damage and require extensive work by a qualified technician to restore the product to its normal operation.
- The product has been dropped or the enclosure has been damaged.
- The product exhibits a distinct change in performance. This may indicate a need for service.

 <b>WARNING</b>
<p><b>Failure to perform a safety check after the controller has been repaired can result in product damage or personal injury due to electrical shock or fire.</b></p> <p>If the controller has been repaired, before putting it back into operation, make sure qualified service personnel perform a safety check.</p>

**8.4 Returning a Damaged Product**

If a product must be returned for service, request a Return Authorization (RA) from Brooks Automation / Granville-Phillips. Do not return products without first obtaining an RA. In some cases a hazardous materials document may be required. The Brooks Automation / Granville-Phillips Customer Service Representative will advise you if the hazardous materials document is required.

When returning equipment to Brooks Automation / Granville-Phillips, be sure to package the products to prevent shipping damage. Circuit boards and modules separated from the controller chassis must be handled using

proper anti-static protection methods and must be packaged in anti-static packaging. Brooks Automation / Granville-Phillips will supply return packaging materials at no charge upon request. Shipping damage on returned products as a result of inadequate packaging is the Buyer's responsibility. *Before you return the module*, obtain an RA number by contacting Granville-Phillips customer service:

- Phone **1-303-652-4400** or **1-800-776-6543** within the USA.
- Phone **1-800-367-4887** 24 hours per day, seven days per week within the USA.
- Email [co-csr@brooks.com](mailto:co-csr@brooks.com)
- For Global Customer Support, go to [www.brooks.com](http://www.brooks.com), click on Contact Us, then click on Global Offices to locate the Brooks Automation office nearest you.

## 8.5 Troubleshooting

If any of the conditions described above have occurred, troubleshooting is required to determine the repairs that are necessary.

**Table 8-1 Symptoms and Possible Causes**

Symptom	Possible Cause
Unit will not power-up, no response to power switch	Power fuse blown Wrong line voltage selection, see <i>Line Voltage</i> on page 53
Power fuse blows repeatedly	Wrong fuse rating Wrong line voltage selection, see <i>Line Voltage</i> on page 53
Micro-Ion gauge will not turn ON, or turns on briefly then shuts OFF	Micro-Ion gauge at too high pressure Auto turn ON/OFF circuit in Convector gauge module is shutting OFF the Micro-Ion Gauge Emission current setting wrong for pressure in gauge Improper Micro-Ion Gauge connector hookup Badly contaminated Micro-Ion Gauge Damaged or contaminated cathode coating, will not sustain emission Short in Micro-Ion Gauge cable Short between Micro-Ion Gauge electrodes Open cathode in Micro-Ion Gauge
Micro-Ion gauge display shows a steady number when the Micro-Ion gauge is OFF	CAL switch is not in the OFF position
Convector Gauge display reads a fixed (non changing) pressure	Micro-Ion Gauge IG AUTO switch is left in the set position or the Convector option

**Table 8-1 Symptoms and Possible Causes**

Symptom	Possible Cause
Pressure reading is higher than expected	Micro-Ion Gauge contaminated UHV pressure range is not selected appropriately (pressure is below $1 \times 10^{-7}$ Torr) Interference from other ion source Poor conductance in gauge's vacuum connection to chamber Gas source in plumbing to gauge, such as leak or contamination Chamber pressure high because of leak, contamination, or pump failure Poor location selected for gauge Faulty gauge or power cable Faulty electrometer
Degas will not turn ON	System pressure above $5 \times 10^{-5}$ Torr Micro-Ion Gauge not turned ON
Micro-Ion Gauge shuts OFF when degas is initiated	Degas fuse blown Badly contaminated Micro-Ion gauge.
Micro-Ion Gauge pressure reads extremely low	Collector unplugged Bad collector cable Faulty electrometer Collector is coated with material
Micro-Ion Gauge pressure readout very erratic	Micro-Ion Gauge badly contaminated Improper Micro-Ion Gauge or Controller grounding Bad collector cable Excessive electrical noise source causing offset Interference from other charged particle source in chamber Faulty electrometer
Green +18 LED out on control board	+18 V supply to relays faulty
Green +15 LED out	+15 V supply faulty (power to analog circuitry and RS-232 overloaded)
Green -15 LED out	-15 V supply faulty (power to analog circuitry and RS-232 overloaded)
Green +5 display LED out	+5 V supply to display LED's faulty or overloaded
Green +5 logic LED out	+5 V logic supply faulty or overloaded

## 8.6 Overpressure Shutdown

As pressure increases, the ion current to the collector increases until the high density of gas molecules begins to interfere with the ionization process. When some electrons cannot acquire sufficient energy to ionize the gas molecules, the collector current no longer increases with increasing pressure. This pressure is called the “turn around” pressure. Further pressure increases will result in a decreasing ion current.

The Controller is factory set so the ion gauge will shut down when the pressure rises above the overpressure setpoint pressures shown in Table 8-2.

For reliable operation in general applications, the overpressure shutdown point is factory set below the Micro-Ion Gauge turn around point at both emission currents. Although we recommend that you do not change the factory settings, the overpressure shutdown can be readjusted for specific applications according to the following procedure.

 **CAUTION**

**Adjusting the overpressure shutdown to a pressure that is higher than the factory setting can damage the gauge and vacuum system.**

Before adjusting the overpressure shutdown to a pressure that is higher than the factory setting, phone a Granville-Phillips application engineer at 1-303-652-4400 or 1-800-776-6543 within the USA, or email [co-csr@brooks.com](mailto:co-csr@brooks.com).

**Table 8-2 Overpressure Shutdown Factory Settings**

Pressure Range Designation	MV (Medium Vacuum)	HV (High Vacuum)	UHV (Ultrahigh Vacuum)
Emission Current	20 $\mu$ A	1 mA	4 mA
Recommended Upper Limit, Torr	$5 \times 10^{-2}$	$8 \times 10^{-4}$	$2 \times 10^{-4}$
Recommended Lower Limit, Torr	$1 \times 10^{-6}$	$1 \times 10^{-7}$	Less than $1 \times 10^{-9}$

To adjust the overpressure shutoff point to a different level:

1. Maintain system pressure at the desired shutoff point.
2. Rotate the overpressure adjustment potentiometer fully counterclockwise.
3. Turn ON the ion gauge.
4. Rotate the adjustment potentiometer clockwise slowly until the ion gauge turns OFF.

**8.7 Troubleshooting the Convectron Gauge Module**

**Table 8-3 Convectron Gauge Module Troubleshooting - See Figure 5-13 on page 82**

Symptom	Possible Cause
Pressure reading grossly in error	Controller out of calibration Unknown gas type Gauge not mounted horizontally (see Figure 4-2 on page 55) Sensor damaged (e.g., by reactive gas) or Gauge very dirty Extremes of temperature or mechanical vibration
CGA over current indicator lit	Cable short, pins 1-3
CGB over current indicator lit	Cable short, pins 1-3
Bridge circuit indicators lit	Circuit failure
CGA unplugged indicator lit	CGA unplugged; open sensor wire
CGB unplugged indicator lit	CGB unplugged; open sensor wire
Microprocessor reset LED lit or flashing	Microprocessor failure
A/D integration failure indicator lit or flashing	Circuit failure
Display reads blank or "—"	Gauge unplugged; open sensor wire

**Convectron Gauge Test Procedure**

The small diameter sensor wire can be damaged by small voltages. Do not perform electrical continuity tests with instruments applying in excess of 1 volt when the gauge is at vacuum, or 5 V when at atmospheric pressure.

The Convectron gauge should show the following resistances (pin numbers are embossed on the gauge connector):

**Figure 8-1 Convectron Gauge Connector**

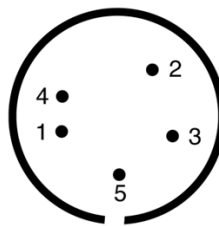

- Pins 1 to 2: 19 to 22 ohms
  - Pins 2 to 3: 50 to 60 ohms
  - Pins 1 to 5: 180 to 185 ohms
- If the resistance from pins 1 to 2 reads about 800 ohms, the sensor wire in the gauge is broken. Replace the gauge tube.

*Note: If the resistance values shown here are correct, but you still think the gauge is not reading correctly, the gold plating on the sensor wire may be eroded and the gauge will have to be replaced.*

## Cleaning Contaminated Convectron Gauges



### WARNING

**Exposure to fumes from solvents in an improperly ventilated area can cause personal injury.**

To avoid personal injury from inhaling fumes from solvents such as trichloroethylene, perchloroethylene, toluene, and acetone, use these solvents only in a well-ventilated area that exhausts to the outdoors.



### WARNING

**Use of flammable solvents near open flame or energized electrical equipment can cause an explosion or fire.**

To avoid product damage or personal injury due to explosion or fire, use flammable solvents such as acetone and toluene only in a well-ventilated area that exhausts to the outdoors. Do not use such solvents near an open flame or energized electrical equipment.

The Convectron Gauge can be baked to 150 °C nonoperating while under vacuum with the Connector removed.

All materials were chosen for ultra high vacuum service, corrosion resistance and bakeability. The envelope is type 304 stainless steel. All metallic joints in the envelope are welded. No solder is used within the envelope. The following materials are exposed to the vacuum: Type 304 stainless steel, Carpenter Alloy 52, Kovar, Kapton, gold plated tungsten, borosilicate glass and Dow-Corning 9015 glass. The blue trim cover is rated at 150 °C.

When the small sensor wire is contaminated with oil or other films, its emissivity or its diameter may be appreciably altered and a change of calibration will result. Cleaning with trichloroethylene, perchloroethylene, toluene, or acetone is possible but it must be done very carefully so as not to damage the sensor.

Hold the gauge with the main body horizontal and the port projecting upward at an angle of 45degrees. Slowly fill it with solvent using a standard wash bottle with the spout inserted in the port to where it touches the screen. Let the solvent stand in the gauge for at least ten minutes. Do not shake the gauge. Shaking the gauge with liquid inside can damage the sensor wire. To drain the gauge, position it horizontally with the port facing downward. Slightly warming the gauge will help dry the gauge. Then allow the gauge to dry overnight with the port open and vertically downward.

**8.8 Capacitance Manometer Troubleshooting** Refer to Figure 4-5 on page 60 to locate the LEDs on the capacitance manometer printed circuit board.

**Table 8-4 Capacitance Manometer Troubleshooting Guide - See Figure 4-5 on page 60**

Symptom	Possible Cause
Unstable reading	Mechanical vibration of capacitance manometer, faulty system ground or cable ground
Display always reads 0	Capacitance manometer cable unplugged, no $\pm 15$ V power, faulty cable
-15V Overcurrent LED is ON	-15 V overcurrent. Defective cable, transducer, or circuit board
CG Unplugged LED is ON	The Convectron Gauge is unplugged
A/D Failure LED ON	A/D failure. Defective Normally Open converter circuit
+15V Overcurrent LED is ON	+ 15 V overcurrent. Defective cable, transducer, or circuit board
Convectron Bridge Out LED is ON	Defective PC board, Convectron bridge circuit
CG Overcurrent LED is ON	Convectron overcurrent. Defective gauge or cable
$\mu$ P Failure LED is ON	Microprocessor failure

**8.9 Process Control Troubleshooting** If the  $\mu$ P FAILURE LED is illuminated or flashing, there is a probable circuit failure. Return this product for repair at a service facility designated by Brooks Automation, Inc.

The setpoints are read from non-volatile memory into RAM when the unit powers up. On power up, a checksum is computed and stored in RAM, and is updated whenever a setpoint is changed. It is then periodically re-computed from the existing setpoints and checked against the pre-existing value. If for any reason (such as a power fluctuation or electrical transient in the system) a setpoint becomes corrupted, this method will trap the error.

If a setpoint is found to contain garbled data which cannot be interpreted as a valid setpoint, the setpoint pressure will be set to 0.



**8.10 RS-232 Troubleshooting**

Because the RS-232 “standard” is found in an array of configurations, the first thing to do if trouble arises is check the following configuration options:

1. Check switch settings.

Be sure the baud rate, character format and framing, and interface protocol are matched to your host computer or terminal's requirements. Note that there may be several mismatched parameters. Check to see if your computer requires the reversed-polarity RTS convention.

2. Check the interface wiring.

The pin designations for the RS-232 connector are listed in Table 3-5 on page 38. Note that the “received” and “transmitted” data lines are defined as seen by the controller. Many companies supply “null modems” or switch boxes for the purpose of reconfiguring the control and communications lines for particular applications.

3. Check the command format.

Be sure the strings you output to the controller are in accord with the syntax defined in *Preparing to use RS-232 Computer Interface* on page 87.

**Table 8-5 RS-232 Troubleshooting Guide**

Symptom	Possible Cause
Microcontroller reset LED lit or flashing. See Figure 3-12 on page 39	Microcontroller failure
No response or garbled output	Baud rate incorrect Character length incorrect or stop bit(s) incorrect Bad cable.
OVERRUN ERROR message	Stop bit(s) incorrect, host software failure
PARITY ERROR message	Parity incorrect
SYNTAX ERROR message	Message to controller not in accord with specified syntax or failure to assert DCD handshake line

**8.11 RS-485 Troubleshooting**

The first thing to do if trouble arises is check the following configuration options:

1. Check switching settings.  
Be sure the baud rate, character format and framing, and interface protocol are matched to your host computer or terminal's requirements. Note that there may be several mismatched parameters.
2. Check the command format.  
Be sure the strings you output to the controller are in accord with the syntax defined in *Preparing to Use RS-485 Computer Interface* on page 90.

**Table 8-6 RS-485 Troubleshooting Guide**

Symptom	Possible Cause
Microcontroller reset LED CR1 lit or flashing	Microcontroller failure
No response or garbled output	Baud rate incorrect. Character length incorrect or stop bit(s) incorrect Bad cable
Responds intermittently	Poor cable connections, ground fluctuations (the maximum common mode potential across the system is 7V) and EMI from other sources. The terminating resistor circuit is not installed, or is improperly installed. If the start character is not received properly, the controller may not interpret it as a start character and the controller will not respond. The Host software must be prepared to re-send a command if a response is not generated within a reasonable period of time.
OVERRUN ERROR message	Stop bit(s) incorrect, host software failure
PARITY ERROR message	Parity incorrect
SYNTAX ERROR message	Message to controller not in accord with specified syntax

---

**8.12 Field Installation of a Module**

1. Turn OFF power to the Controller.
2. With power OFF, remove any cables from the Controller rear panel.
3. Observe antistatic precautions to avoid damaging static sensitive components inside the chassis. Use a grounded, conductive work surface. Do not handle MOS devices more than absolutely necessary, and only when wearing a high impedance ground strap. Use conductive envelopes to store or ship MOS devices or printed circuit boards. Do not operate the Controller with MOS devices removed from the printed circuit boards.
4. See *Top Cover Removal* on page 27 for how to remove the top cover.
5. Locate correct position for module.
6. Carefully remove the bus ribbon cable from all modules located to the right (as you face the front panel) of the position where the module is to be installed. Remove connectors slowly using pull tabs.
7. Lift out the filler module at the position where the module is to be installed.
8. Install the module in its proper position making sure all ends lock together.
9. Carefully reconnect the bus ribbon connectors.
10. Select appropriate switch settings. See Chapter 2.
11. Replace the top cover as instructed in *Replacing the Controller Cover* on page 47.



## A

- Analog outputs
  - connecting **59**
  - Convectron gauge **82**
  - Micro-Ion gauge **69**

## B

- Before you begin
  - caution and warning statements **9**
  - certification **11**
  - FCC verification **12**
  - pressure relief devices **11**
  - reading and following instructions **9**
  - service guidelines **11**
  - warranty **11**

## C

- Capacitance Manometer
  - Analog Output Signal **61**
  - Initial Transducer Calibration **85**
- Capacitance manometer
  - specifications **23**
  - theory of operation **103**
- Caution and warning statements **9**
- Certification, product **11**
- Chapters
  - Before You Begin **9**
  - Initial Setup **27**
  - Installation **49**
  - Operation **95**
  - Preparing for Operation **67**
  - Service **105**
  - System Components **13**
- Controller
  - dimensions **23**
  - installation **50**
  - line voltage **53**
  - mounting configurations **51**
  - operation **95**
  - options **21**
  - removing top cover **27**
  - replacing top cover **47**
  - setup **27**
  - specifications **20**

- Convectron gauge
  - analog output **1 82**
  - installation **53**
  - mounting options **54**
  - preparing for operation **71**
  - pressure units setup **30**
  - specifications **22**
  - theory of operation **102**
  - troubleshooting **110**
  - with connector **24**
  - zero and atmospheric pressure adjustment **81**
- Convectron gauge zero and atmospheric pressure adjustment **81**
- Convectron module
  - display update rate **31**
- Customer service **106**

## D

- Damage requiring service **10, 106**
- Dimensions
  - controller **23**
  - Convectron gauge with connector **24**
  - Micro-Ion gauge with connector **24**
- Display
  - Convectron module update rate **31**
  - electrometer module update rate **30**

## E

- Electrometer module
  - display update rate **30**
  - filament selection **100**
  - pressure units setup **28**
- Environmental conditions **50**
- EU installation requirements **49**

## F

- FCC installation requirement **49**
- FCC verification **12**
- Fuse replacement **53**

## G

- Grounding **55**

- I**
- Installation
- analog outputs **59**
  - cable **50**
  - controller **50**
  - controller line voltage **53**
  - Convectron gauge **53**
  - environmental conditions **50**
  - FCC and EU installation requirements **49**
  - fuse replacement **53**
  - gauge installation tips **49**
  - in the field **115**
  - mounting configurations **51**
  - mounting options **54**
  - relays **63**
  - RS-232 connections **65**
  - RS-485 connections **66**
  - system grounding **55**
- M**
- Maintenance
- troubleshooting **107**
- Micro-Ion gauge
- alternate ON/OFF **68**
  - analog output **69**
  - filament selection **100**
  - operation **98**
  - pressure range **22**
  - specifications **21**
  - theory of operation **101**
  - with connector **24**
- O**
- Operation
- controller **95**
  - electrometer module filament selection **100**
  - Micro-Ion gauge **98**
  - theory **101**
- Overpressure shutdown **30**
- P**
- Preparing for operation **81**
- Convectron gauge **71**
  - Micro-Ion gauge alternate ON/OFF **68**
- Micro-Ion gauge analog output **69**
  - pressure measurement **67**
  - process control **84, 85**
  - RS-232 protocol **87**
  - RS-485 protocol **90**
- Pressure
- overpressure shutdown **109**
  - true versus indicated **74–79**
  - units setup **28**
- Pressure relief devices **11**
- Process control
- preparing for operation **84, 85**
  - theory of operation **103**
  - troubleshooting **112**
- R**
- Reading and following instructions **9**
- Relays
- installation **63**
  - polarity setting **35**
- RS-232 protocol
- command set
    - DG **88**
    - DGS **88**
    - DS **88**
    - IG1 **89**
    - PCS **89**
  - connecting **65**
  - interface setup **37**
  - preparing for operation **87**
  - specifications **18**
  - troubleshooting **113**
- RS-485 protocol
- command set
    - DG **91**
    - DGS **91**
    - DS **91**
    - IG1 **89, 92**
    - PCS **92**
  - connecting **66**
  - interface setup **42**
  - preparing for operation **90**
  - specifications **19**
  - troubleshooting **114**

**S**

## Service

- damage requiring **106**
- field installation **115**
- guidelines **11, 105**
- overpressure shutdown **109**
- troubleshooting Convectron gauge **110**
- troubleshooting process control module **112**
- troubleshooting RS-232 protocol **113**
- troubleshooting RS-485 protocol **114**

## Setup

- controller **27**
- Convectron gauge pressure units **30**
- Convectron module update rate **31**
- electrometer module **28**
- overpressure shutdown **30**
- pressure units **28**
- process control **32**
- relay polarity **35**
- removing top cover **27**
- replacing controller top cover **47**
- RS-232 protocol **37**
- RS-485 protocol **42**

## Specifications

- capacitance manometer **23**
- controller **20**
- controller options **21**
- Convectron gauge **22**
- Micro-Ion gauge **21**
- Micro-Ion gauge pressure range **22**
- Micro-Ion system **20**
- RS-232 protocol **18**
- RS-485 protocol **19**

## System components

- computer interface module options **17**
- process control relay options **17**

**T**

## Theory of operation

- capacitance manometer **103**
- Convectron gauge **102**
- Micro-Ion gauge **101**
- process control **103**

## Troubleshooting

- Convectron gauge module **110**
- process control module **112**
- RS-232 protocol **113**
- RS-485 protocol **114**
- True versus indicated pressure **74–79**

**W**

- Warranty **11**







## Series 358

# Granville-Phillips® Series 358 Micro-Ion® Vacuum Gauge Controller



**6450 Dry Creek Parkway**

Longmont, CO 80503 USA

Phone: 1-303-652-4400

**15 Elizabeth Drive**

Chelmsford, MA 01824 USA

Phone: 1-978-262-2400

Worldwide Customer Service/Support - 24/7

Phone: 1-800-367-4887

To obtain a copy of this instruction manual online,  
visit our website at [www.brooks.com](http://www.brooks.com)

(Adobe® Reader® version 5.0 or higher required)

© 2007-2008 Brooks Automation, Inc.

## Instruction Manual

*Instruction manual part number 358013*

*Revision 09 - June 2008*